

CR-1616

DIMENSIONS (MM)

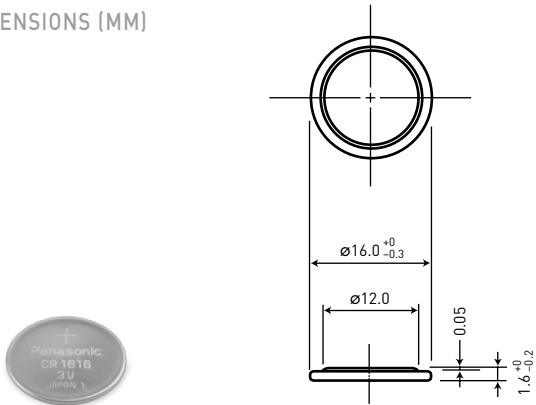

Model number	CR-1616
Nominal voltage (V)	3
Nominal capacity (mAh)	55
Diameter (mm)	16.0
Total height (mm)	1.6
Discharging temperature range (°C)	-30 to +60
Weight (g)	1.2

DISCHARGE TEMPERATURE CHARACTERISTICS

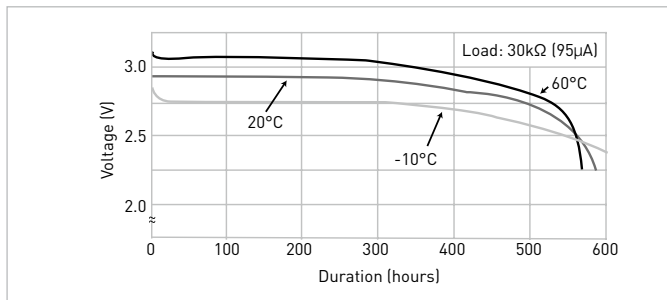

OPERATING VOLTAGE VS. DISCHARGE CURRENT*1

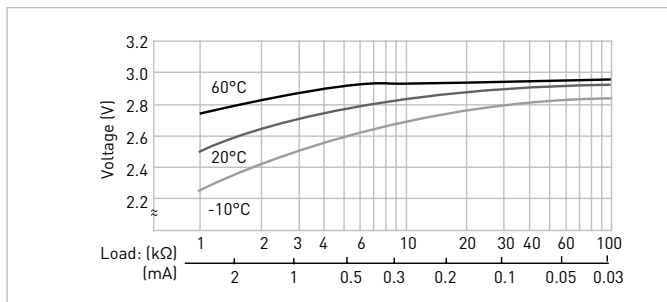

CAPACITY VS. LOAD RESISTANCE

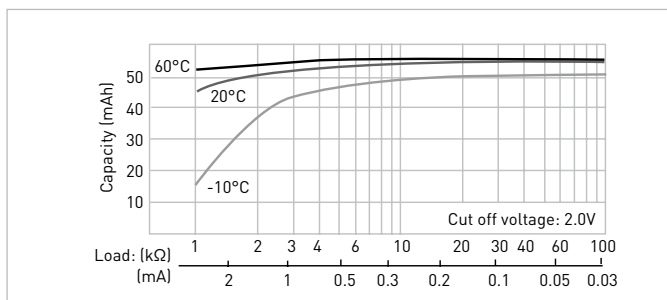

CR-1620

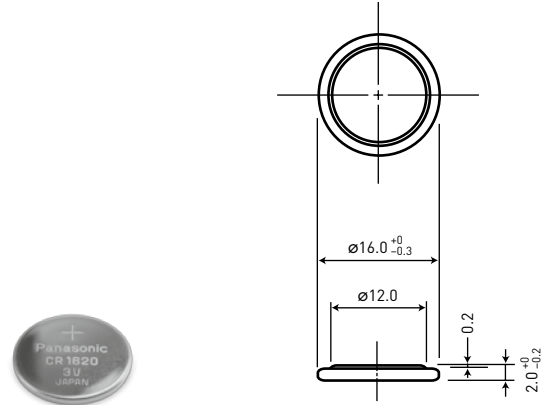

Model number	CR-1620
Nominal voltage (V)	3
Nominal capacity (mAh)	75
Diameter (mm)	16.0
Total height (mm)	2.0
Discharging temperature range (°C)	-30 to +60
Weight (g)	1.3

DISCHARGE TEMPERATURE CHARACTERISTICS

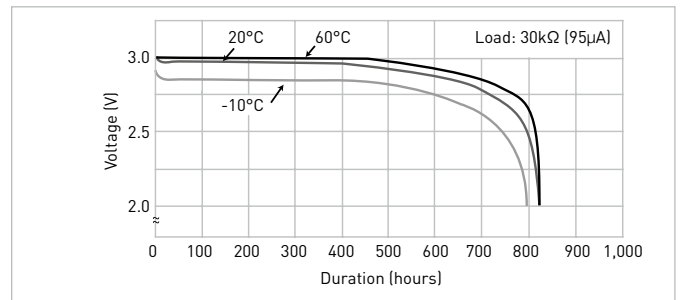

OPERATING VOLTAGE VS. DISCHARGE CURRENT*1

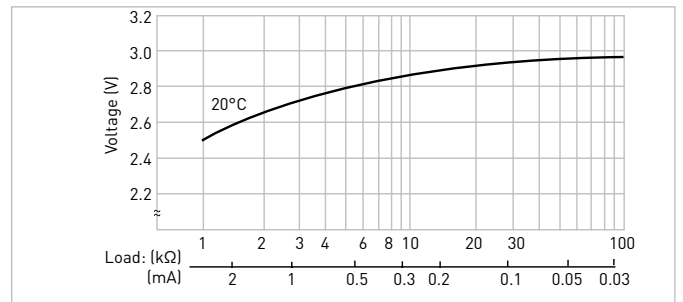

CAPACITY VS. LOAD RESISTANCE

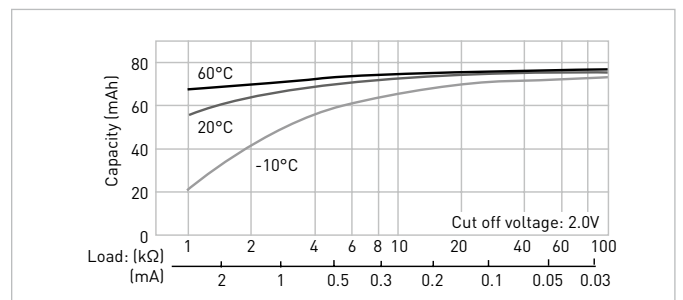

The data in this document are for descriptive purposes only and are not intended to make or imply any guarantee or warranty.
*1 Voltage at 50% discharge depth.