

**Cadex C7000 C-Series
Battery Analyzer
User's Manual
Cadex C7200, C7400 & C7400ER (C-Series)**

Cadex Electronics Inc.

22000 Fraserwood Way
Richmond, British Columbia
Canada V6W 1J6

Tel: +1 604 231-7777 Fax +1 604 231-7755

Web: www.cadex.com E-mail: info@cadex.com

Manual P/N: 89-307-1016

Document Number PSMAN0048 Rev7

September 2009

Firmware Version 1.10

Trademark

Cadex, BatteryShop, QuickLearn, QuickTest, QuickSort, FlexArm, RigidArm are registered trademarks of Cadex Electronics Inc. All other trademarks mentioned herein are the property of their respective owners.

Copyright

Copyright © 2008 by Cadex Electronics Inc. All rights reserved. No part of this publication or the firmware controlling Cadex product(s) may be reproduced, transmitted, transcribed, stored in a retrieval system, or translated into any language or computer language in any form or by any means without the express written permission of Cadex Electronics Inc.

Revision Rights

Cadex Electronics Inc. reserves the right to revise this publication and make changes in the contents thereof without obligation to notify any person of such changes. Please e-mail service@cadex.com for suggestions or corrections.

Disclaimer

While every effort is made to ensure that the information contained in this manual is accurate and up-to-date, Cadex Electronics Inc. does not warrant or guarantee the accuracy of the contents of this manual. Further, Cadex makes no warranties, either expressed or implied, as to the merchantability or fitness for a particular purpose of the Cadex C7000 C-Series Battery Analyzers (C7200-C, C7400-C and C7400ER-C) equipment and/or its documentation.

In no event will Cadex or its officers or employees be held responsible for any consequential, incidental, or indirect damages (including damages for loss or business profits, business interruption, and the like) arising out of the use or inability to use the Cadex C7000 C-Series Battery Analyzers (C7200-C, C7400-C and C7400ER-C) Battery Analyzer equipment and/or its documentation.

Safety Notices

Use of Equipment

The Cadex C7000 C-Series Battery Analyzers (C7200-C, C7400-C and C7400ER-C) are designed with adequate safeguards to protect the user from shock and other hazards when used as specified within this document. However, if the equipment is used in a manner not specified by this documentation, the protection provided by this equipment may be impaired. Please read this document and equipment labeling before using the equipment.

Modification of Equipment

CE, FCC, CSA and other approvals apply only to Cadex C7000 C-Series Battery Analyzers (C7200-C, C7400-C and C7400ER-C) in the factory-authorized configuration. Changes or modification to the equipment not expressly approved by Cadex will void the approvals and void the user's authority to operate the equipment.

Disposal of Waste Electrical and Electronic Equipment (WEEE) in the European Union



This symbol on the product and package indicates that this product must not be disposed of with unsorted municipal waste. Instead, it is your responsibility to dispose of WEEE by handing it over to a designated collection point for the disposal. The separate collection and recycling of waste equipment will help conserve natural resources and ensure that it is disposed of in a manner that protects human health and the environment. For more information about where you can drop off your waste equipment for disposal, please contact your local municipal office, waste disposal service or wherever you purchased the product.

ROHS Compliance

The C7000 C-Series of Battery Analyzer complies with the European Union's Directive 2002/95/EC, Restrictions of Hazardous Substances (RoHS).

Radio Interference



This equipment generates, uses and radiates radio frequency energy. If the equipment is not installed and used in accordance with the instructions in this manual, it may cause interference with radio communications. The equipment has been tested and found to comply with the limits for a Class "A" digital device pursuant to Subpart B of Part 15 of the FCC Rules, which are designed to provide reasonable protection against such interference when operated in a commercial environment. Operation of this equipment in a residential area may cause interference, in which case the user is required to take whatever measures needed to correct the interference, at their own expense.

EN55011/EN55022 Warning: This is a Class A product according to EN55011/EN55022. In a domestic environment, this product may cause radio interference, in which case the user, at their own expense, may be required to take adequate corrective measures.

The equipment is designed with adequate safeguards to protect the user from shock and other hazards when used as specified within this document. If the equipment is used in a manner not specified by this documentation, the protection provided by the equipment may be impaired. Please read the documentation and equipment labeling before using the equipment.

The analyzer may be affected by interference from other devices. If the unit is running abnormally, please ensure that the analyzer is moved away from any source of radio interference.

Explosion Hazard



Batteries can burst if treated improperly. Follow these precautions at all times.

- ✓ Clean battery contacts before servicing. To clean battery contacts, use a lint-free cotton swab dipped in 100% isopropyl alcohol.
- ✓ Press the battery firmly into the adapter to ensure a good connection.
- ✓ Ensure that the selected C-code is correct for the chemistry, voltage, and rating of the battery being serviced.
- ✓ Observe battery temperature. Service batteries between 5°C (41°F) and 50°C (122°F). Stop service if battery becomes very hot. The temperatures cited here are the battery temperatures, not ambient the ambient temperatures. Fast charging outside this temperature range may damage or reduce the life of the battery. Allow cold batteries to warm up and hot batteries to cool before charging.
- ✗ Do not attempt to charge non-rechargeable and primary batteries such as alkaline, carbon-zinc, or non-rechargeable lithium batteries.
- ✗ Do not short the positive and negative battery terminals together at any time.
- ✗ Do not connect leads from one station to another, or to the case. An electrical short to any point outside the station bypasses the current regulation loop and may blow a fuse or cause permanent component damage.
- ✗ Do not exceed the battery manufacturer's recommended charge current and voltage limits for batteries.
- ✗ Do not remove the adapter from the analyzer while the battery is running.

Charging and Discharging Lithium-ion (Li-ion) Batteries

Lithium-ion (Li-ion) batteries are safe when used as directed. Battery safety cannot be assured when a battery pack is built with individual cells of an unknown nature with a serial and parallel connection. Not all Li-ion cells are suited for multi-cell packs. Only cells that meet tight voltage and capacity tolerances can be used for serial and parallel connection. Mismatched packs are subject to overcharge resulting in venting with flame and fire. Check with the cell manufacturer to see if the cells are suitable for multi-cell packs.

In the past, single Li-ion cells were only available to authorized battery manufacturers. Today, imports are becoming readily available and often fall into the hands of the inexperienced. While most brand name cells are equipped with an internal cell disconnect that permanently opens the current path on high pressure, some brands do not provide this safeguard. Many brands don't use a separator that shuts down the battery when high temperatures are reached. The internal safety features are omitted for cost reasons.



Please follow the following guidelines when charging and discharging lithium-ion cell(s) and packs. Failing to follow these rules could result in venting with flame, explosion, fire and personal injury.

- ✘ Never connect cells in parallel and/or series that are not designed for that purpose. A cell mismatch may overcharge and vent with flames.
- ✘ Never charge or discharge the battery without connecting a working protection circuit. Each cell must be monitored individually and the current disconnected if an anomaly occurs.
- ✘ Never leave the battery unattended while under charge or discharge.
- ✓ Always attach a temperature sensor when charging and discharging the battery. The temperature sensor must disconnect the current on excess temperature.
- ✓ Only connect cells that are matched and have the identical state-of-charge.

Safety Notices

- ✓ Pay special attention when using an unknown brand. Not all brands contain intrinsic safety features that protect the cell when stressed.
- ✓ During experiments, place the test battery into a well-ventilated fireproof container.

Shock Hazard



The Cadex Battery Analyzer contains high-voltage circuits, and can pose a shock hazard when the upper cover is removed. Do not attempt to perform any service procedures on the analyzer other than replacement of the external fuse (see Chapter 11, Services and Upgrades, page 109).

- ✓ To reduce the risk of electrical shock hazard, service batteries only when they are removed and disconnected from their end-use equipment.
- ✓ Use the analyzer only as specified in the documentation. Other uses may impair the protection provided by the unit.
- ✓ Use only a grounded AC outlet to power the analyzer.
- ✓ Before attempting any internal service, remove all batteries from the battery stations, turn the analyzer off and disconnect the power cord from the wall socket. Wait a few minutes before opening the cover.
- ✓ Replace fuses only with fuses of the same type and rating (see Replacing the Primary (Input) Fuse, page 109).

Warranty & Service

Cadex Electronics Inc. warrants the Cadex Battery Analyzer against defective materials and workmanship for a period of two (2) years from the original purchase date.

The warranty does *not* cover:

- Damage caused by abusive operation, negligence, accident, or improper installation.
- Damage caused by an attempted repair not authorized by Cadex.
- Cosmetic damage or similar.
- Normal wear and tear.
- Damage from external causes such as leakage spills, power fluctuations or power failure.
- Damage caused by inadequate packaging for shipping or storage.
- Product received without the appropriate model number, serial number, or safety markings.
- Products used for rental purposes.

Warranty Service

Before sending the unit for service, contact Cadex Technical Support at

E-mail: contact service@cadex.com

(Canada) 1-604-231-7777

(USA Toll Free) 800-565-5228

(Europe) +49 (0) 911 240 332-0.

If the product requires warranty service, the representative will provide a Return Authorization form or number and the location of the nearest service center.

- Ship the product to the service center with freight, insurance, and customs duties prepaid. The Return Authorization form must be included to obtain warranty service.
- Ensure that the unit(s) is properly packed before shipping, preferably in the original Cadex boxes. Damage caused in transit due to improperly packed items is not covered under warranty.
- Products returned from warranty service are shipped with freight prepaid by Cadex.

Non-Warranty Repairs

Before sending the unit in for service, contact Cadex Technical Support at;

E-mail: contact service@cadex.com

(Canada) 1-604-231-7777

(USA Toll Free) 800-565-5228

(Europe) +49 (0) 911 240 332-0.

If the analyzer is not covered by warranty, the representative will provide the contact information for the nearest service center. Contact the service center directly to arrange to send the product in for service. A Return Authorization form or number will be provided only if the product is returning to the Cadex Head Office.

- Ship the product to the service center with freight, insurance and customs duties prepaid.
- Ensure that the unit(s) is properly packaged before shipping.

Note Cadex Electronics Inc. and Cadex authorized service centers require a Purchase Order or written authorization to proceed with repair.

Table of Contents

Chapter 1	Overview	1
	Product Features	1
	Connecting to Cadex BatteryShop™	2
Chapter 2	Getting Started	3
	Contents of the Box	3
	Using this Manual	3
	Conventions	5
	Direction Keys	5
	Symbols	5
	Abbreviations and Acronyms	6
	Commonly Used Terms	7
Chapter 3	Operating Principles	10
	Components	10
	Front LCD Display Interface	13
	Lights (LEDs)	15
	Menu Structure	16
	Battery Adapters	17
Chapter 4	Basic Battery Service.....	20
Chapter 5	Battery Service Programs	25
	Basic Programs	25
	Auto	26
	Charge	27
	Prime	27
	QuickSort	28

Advanced Programs	30
SelfDCH (Self-Discharge Test)	31
Life-Cycle	32
DCHOnly (Discharge Only)	34
ExtPrime (Extended Prime).....	35
OhmTest	35
Runtime.....	37
Boost.....	38
Learn.....	40
Q-Learn (QuickLearn)	41
QuickTest™	44
Custom 1, 2, 3, and 4.....	45
Battery Service Times.....	46
Chapter 6 C-codes (Configuration Codes).....	47
Basic C-code Parameters	48
Program	48
Target Capacity.....	49
Chemistry	49
Battery Voltage (Volts)	49
Battery Rating (mAh).....	50
C-code Setup Name.....	50
Scaled C-code.....	51
C-code Matrix.....	51
Locked C-code	51
Extended C-code Parameters.....	51
Charge Rate.....	51
Discharge Rate	52
Trickle-Charge Rate (NiCd and NiMH only)	53
Recondition Discharge Rate (NiCd and NiMH only)	53
Temperature Sensing.....	53
Negative Slope (NiCd and NiMH only)	54
End-Of-Discharge	54
End of Recondition (NiCd and NiMH only)	55
Charge Method (NiCd and NiMH only).....	56
Maximum Standby Voltage (SLA and Li-ion only)	56

Maximum Charge Voltage (SLA and Li-ion only)	57
End of Charge (SLA and Li-ion only)	57
Default Extended C-code Settings.....	57
Default Extended C-code for NiCd Batteries	58
Default Extended C-code for NiMH Batteries.....	58
Default Extended C-code for SLA Batteries	59
Default Extended C-code for Li-ion Batteries	59
Default Extended C-code for Li-Ph Batteries	59
Extended C-code Settings for Special Cases	60
Intrinsically Safe Batteries.....	60
Hawker SLA Batteries.....	60
Gell SLA Batteries.....	61
Managing C-codes	61
Select a C-code	61
Display a C-code	61
Change Target Capacity or Program	62
Create or Edit a C-code	62
Add or Edit the C-code Setup Name.....	64
Reset Extended C-code to the Default settings	64
Delete a C-code	65
Copy a C-code (including QuickTest matrix).....	65
Copy all C-codes (and matrices) from One Adapter to Another	65
Chapter 7 System Setup And Options	67
Date and Time.....	67
Company Name.....	67
Sound Options.....	68
Voltage Display.....	69
Battery Service Counter	70
Connecting to BatteryShop or a Printer	71
Connecting to BatteryShop	71
Connecting Other Devices to the Serial Port	72
Security	74
Security Level Functions.....	74

Program Parameters.....	77
Starting Battery Service	77
Performing an Automatic OhmTest	78
Optimizing Charge Time or Capacity	79
Termination Condition on dT/dt	79
Saving Program and Target Capacity Settings	80
Resuming Service After Power Failure.....	81
Short Key Functions.....	82
Recalibration Counter	82
Chapter 8 Reports and Labels	83
Automatically Print Reports or Labels (Auto-Print).....	86
Automatic Report or Label printing	86
Manually Print Reports and Labels	87
Chapter 9 Events and Data Logs	89
Logging Events	89
Setting up the Event Log	89
Using the Event Log	90
Logging Data	91
Sample text strings.....	94
Setting up the Data Log	96
Using the Data Log	98
Chapter 10 Custom Programs.....	100
Cycle 1 and Cycle 2	101
Test.....	102
IF Statements.....	102
THEN and ELSE Statements	104
Phase Done	104
Creating and Editing Custom Programs.....	105
Sample Custom Program	107
Chapter 11 Services and Upgrades	109

Replacing the Primary (Input) Fuse	109
Upgrading the Firmware	110
Resetting the System	110
Cleaning the Analyzer	111
Chapter 12 System Calibration	112
Voltage Calibration	112
Servicing the Voltage Calibration Adapters	113
Adapter Calibration	113
Adapter Calibration Values	114
Acceptable Calibration Values for New Adapters	114
Chapter 13 Solving Problems and Getting Help	116
Troubleshooting	116
Manual Updates and Other References	120
Technical Support	121
Appendix A Messages and Warnings	123
Non-Coded Messages	124
By Code	125
By Detailed Message	129
Appendix B Charge Algorithms	148
NiCd and NIMH batteries	148
SLA, Li-ion and Li-Ph Batteries	150
Appendix C Specifications	152
Hardware	152
Appendix D Parts and Accessories	154

Chapter 1 Overview

The Cadex C7000 C-Series of Battery Analyzers include the C7200-C, C7400-C and C7400ER-C.

Product Features

- Services rechargeable nickel-cadmium (NiCd), nickel-metal hydride (NiMH), sealed lead-acid (SLA), lithium-ion (Li-ion), lithium-polymer (treated in the same way as Li-ion) and Lithium-phosphate (Li-Ph). In this manual “Li-ion” refers to both lithium-ion and lithium-polymer batteries.
- Programmable with a total of 17 programs including:
 - Four basic programs: Auto; Charge; Prime and QuickSort.
 - Ten advanced programs
 - Four user-programmable programs.
- Battery Adapters allow convenient interface to all battery types. Over 1000 custom Battery Adapters are available and specialty adapters can be ordered.
- Adapters can be programmed with 10 C-codes. C-codes contain the chemistry, voltage and rating. Custom adapters are provided with C-codes of the most common batteries.
- A menu-driven interface with messages in plain English and status lights.
- Prints battery service reports and battery service labels.
- Analyzers can be connected to a PC and operated with BatteryShop™ software.
- BatteryShop™ software allows automated operation and networking of multiple analyzers.

Connecting to Cadex BatteryShop™

BatteryShop™ is a powerful Windows-based battery management software tool that allows automation of the Cadex battery analyzer functions to increase productivity.

- Provides control and monitoring of large-scale battery services by connecting up to 120 Cadex analyzers to service up to 480 batteries simultaneously.
- Provides easy access to a database of information for over 1000 battery models, including C-code settings. Even a novice user can perform a variety of tests and programs.

To find out how Cadex BatteryShop™ can enhance battery maintenance, contact Cadex Electronics Inc (see *Connecting to BatteryShop™*, page 71).

Chapter 2 Getting Started

Contents of the Box

- The Cadex Battery Analyzer package includes these items:
- One Cadex Battery Analyzer
- One IEC320 Power Cord (North American Version)
- One User's Manual

Using this Manual

The **Cadex C7000 C-Series Battery Analyzer User's Manual** contains the concepts, procedures and other information necessary to operate the Cadex battery analyzer equipped with firmware version 1.10.

Chapter 1 - Overview provides basic information about product features and connecting the Cadex analyzer to a computer.

Chapter 2 - Getting Started goes through the items that are included with the analyzer and how the manual works. It also explains common symbols, abbreviations, acronyms and commonly used terms.

Chapter 3 - Operating Principles provides information about the Cadex analyzer, components, display screen, interface and how to use Battery Adapters with the analyzer.

Chapter 4 - Basic Battery Service provides the basic procedures for servicing a battery.

Chapter 5 - Battery Service Programs provides detailed information about all the battery service programs.

Chapter 6 - C-codes (Configuration Codes) provides detailed information on selecting and managing battery parameters (C-codes).

Chapter 7 - System Setup and Options describes the analyzer's menu system and provides information about modifying the operation of the analyzer to suit particular needs. Refer to this chapter when connecting devices to the analyzer (i.e. printers or a PC with BatteryShop™ software).

Chapter 8 - Reports and Labels provides information about printing battery service reports and labels.

Chapter 9 - Events and Data Logs describes methods of obtaining and graphing detailed voltage/current/temperature/impedance analysis.

Chapter 10 - Custom Programs describes how to create user-defined programs for specialized or advanced applications.

Chapter 11 - Services and Upgrades provides information on servicing the Cadex analyzer, including upgrading the firmware.

Chapter 12 - System Calibration provides instructions for calibrating the analyzer.

Chapter 13 - Solving Problems and Getting Help provides solutions for common problems that may occur when operating the analyzer.

Appendix A - Messages and Warnings provides detailed information on fault codes and messages that appear on the display.

Appendix B - Charge Algorithms describes the charge and discharge algorithms.

Conventions

Typeface	Meaning
SMALL CAPS	Menu options to select Default settings
BOLD SMALL CAPS	Names of keys on the battery analyzer
<i>Italics</i>	Emphasized words
<i>Bold & Italic</i>	References to other sections in this manual

Direction Keys



Direction keys are represented in this manual as follows:

UP = ▲
DOWN = ▼
LEFT = ◀
RIGHT = ▶

Symbols



Information that, if ignored, can result in damage to the battery analyzer, adapters or battery.



Potential shock hazard.



Potential explosion hazard.

Abbreviations and Acronyms

Abbreviation	Name or Term
16k adapters	These adapters have the extra memory to handle QuickTest. Adapters are marked “16K” on the rear label.
AWG	American wire gauge (a U.S. wire size standard)
LCD	Liquid Crystal Display (also called <i>display</i>)
LED	Light Emitting Diode (also called <i>light</i>)
Li	Lithium-ion and Lithium-polymer battery chemistry
Li-ion	Lithium-ion battery chemistry
Li-Ph	Lithium-phosphate chemistry
Li-polymer	Lithium-polymer battery chemistry. This chemistry is treated in the same way as Li-ion.
mA	Milliampere
mAh	Milliampere hour
mOhm	Milliohm
NiCd	Nickel-cadmium battery chemistry
NiMH	Nickel-metal-hydride battery chemistry
OEM	Original equipment manufacturer
PC	IBM compatible personal computer
RF	Radio frequency
P/N	Part number
SoC	State-of-charge

Abbreviation	Name or Term
SoH	State-of-health
SLA	Sealed Lead Acid battery chemistry
USB	Universal Serial Bus

Commonly Used Terms

Term	Explanation
Milliamper Hour (mAh)	Battery capacity or rating. A battery that provides a current of 1000 milliamperes for 1 hour is rated at 1000mAh (or 1Ah).
Battery	A combination of cells.
Capacity	The amount of energy that a fully charged battery is capable of holding.
Configuration Code (C-code)	Battery parameters stored in Battery Adapters that tell the Cadex analyzer how to service a specific battery type (see Chapter 6 - <i>C-codes (Configuration Codes)</i> page 47).
Cells	Individual items within the battery.
Cycle	One charge and discharge sequence, even if the battery is only partially charged or discharged.
C-rate	A "C" number is a value that is used to calculate charge and discharge times. A battery rated at 1000mAh provides 1000mA for one hour if discharged at 1C. A discharge of 1C draws a current equal to the rated capacity. The same battery discharged at 0.5C would provide 500mA for two hours.
Battery cycle	A charge followed by a discharge (or a discharge followed by a charge). Even when batteries are partially charged and discharged, a cycle is considered to have occurred.

Term	Explanation
Intrinsically Safe (I/S)	Batteries with built-in safety protection circuitry. These batteries are used in volatile environments.
Memory	Reversible capacity loss in NiCd and NiMH batteries caused by an increase in the size of crystals formed within the battery.
Matrix	The set of battery parameters for a specific battery model stored during the Q-Learn or Learn process and used for testing batteries of the same model during QuickTest. A matrix is stored with a C-code.
Recondition	A deep discharge below 1.0V/cell with a controlled current. Reconditioning helps break down large crystals, which develop as a result of memory, to more desirable small sizes often restoring the battery to its full capacity. Applies to NiCd and NiMH only.
Residual Capacity	Capacity remaining in the battery when it is inserted in an analyzer.
Resistance	Also called internal resistance. Opposition to current flow and dissipation of energy in the form of heat.
Self-Discharge	Battery capacity lost during storage because of internal leakage between the positive and negative cell plates.
Smart Battery	Battery equipped with circuits that can communicate with a charger.
State-of-charge	The current energy content of a battery.
State-of-health	The battery condition that takes into account its capacity, resistance and self-discharge.
Target Capacity	The capacity level (in percentage of manufacturer-stated battery capacity) that a battery must display to pass a test of battery capacity. The target capacity is an arbitrary benchmark set by the user. By default it is set to 80% but it can be changed.
Trickle Charge	Maintenance charge to compensate for battery self-discharge.

Term	Explanation
User Interface	The front panel of the analyzer that provides information about the status of the analyzer and any batteries being serviced: It consists of the LCD display, the LED indicators and the input keys.

Chapter 3 Operating Principles

Components

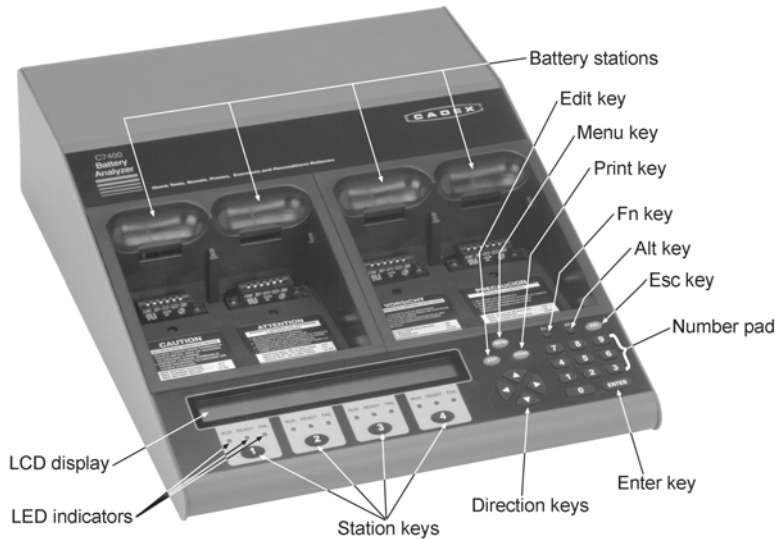

Figure 1: Top and front panel of C7400-C & C7400ER-C Battery Analyzer

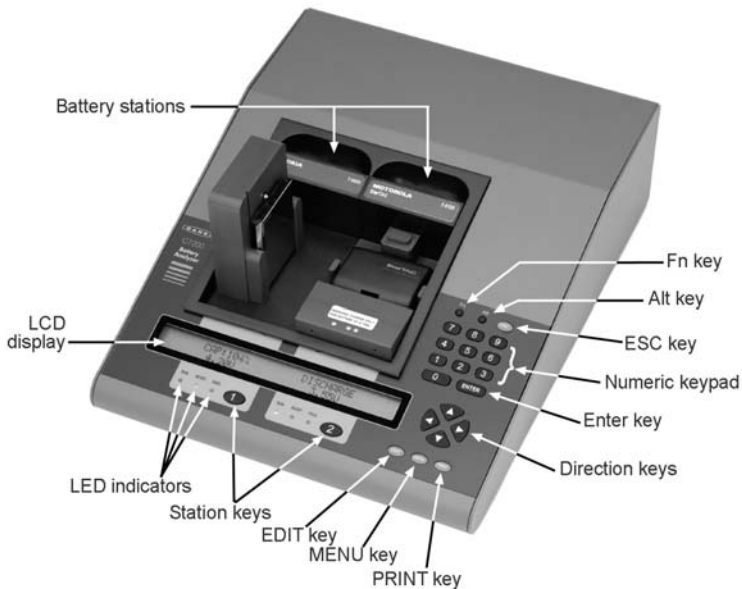

Figure 2: Top and front panel of a C7200-C Battery Analyzer

Component	Function
Battery stations	Slots where the Battery Adapter is inserted. The C7400-C and C7400ER-C has four, the C7200-C has two.
Station keys	Displays C-codes or details of a service. The C7200-C has two, the C7400-C and C7400ER-C has four
PRINT key	Prints labels and reports.
EDIT key	Edits the C-code (battery parameters)
ESC key	Used to exit menus, cancel changes, clear detailed displays.
FN key	Provides shortcuts to common functions or special features.
ALT key	Provides access to special services.
ENTER key	Save settings, start battery service and enter sub-menus.
MENU key	Access a list of options to set up the analyzer.

Component	Function
Numeric keypad	Enter passwords or numeric values in a C-code.
Direction keys	Navigate menus, move between fields, select values, view service details.
LED indicators	View current status of batteries in service (activated when a service starts). Ready (Green): Service complete and/or battery has passed. Fail (Red): Battery service has failed or there is a fault. Run (Yellow): Service in progress.
LCD display	2x40 character screen to display information on each station and its details, to view Menu items.



Figure 3: Rear panel of Cadex battery analyzer

Component	Function
On/Off Power Switch	Turns the analyzer On and Off.
IEC 320 AC Input	Connect the unit to an AC electrical power source with the IEC 320 power cord (North American version supplied).
RS232 serial port (9-pin) & USB Port	To connect to the serial port of a computer to upgrade the firmware, to use BatteryShop or to monitor data, or to print to a label printer. USB port cannot be connected to a printer.
Cooling Fan	Operates continuously to keep the interior of the analyzer at an optimum working temperature. Do not restrict the airflow of the analyzer. Leave the fan opening clear. Fan operation is automatic.

Component	Function
Primary Input Fuse	Protects the unit from internal short circuits. Can be replaced (see <i>Replacing the Primary (Input) Fuse</i> , page 109).

Front LCD Display Interface

The LCD display has 2 rows with 40 characters on each row. It has three main states:

- The Global Display shows the general status of all stations This is the default view for the C7400-C and C7400ER-C.

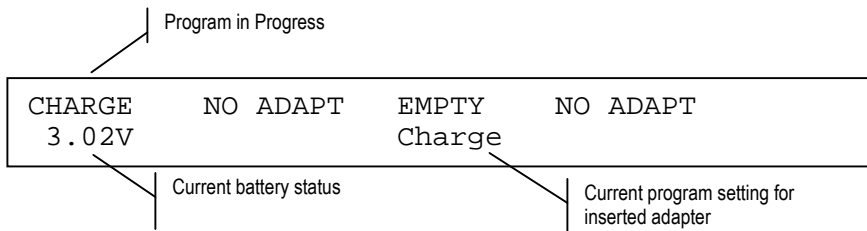
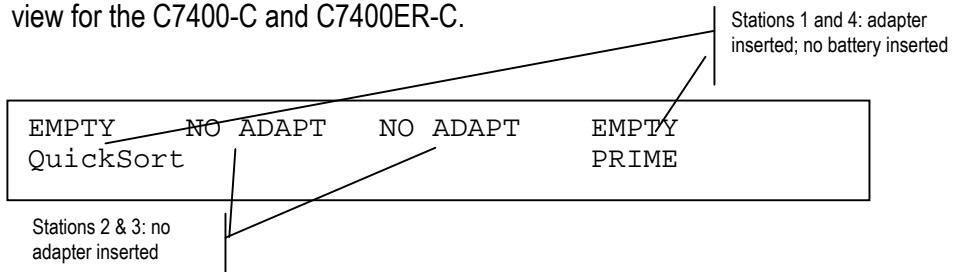

This is the default view for the C7200.

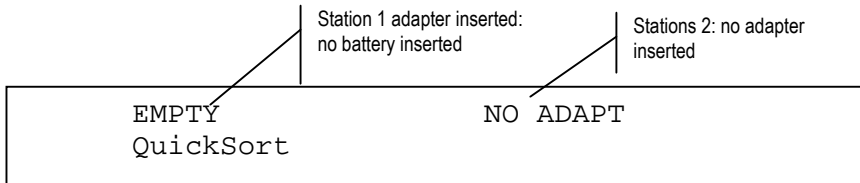

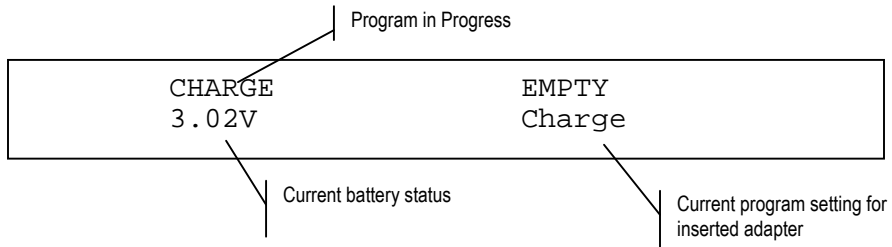

- The Detailed Display provides detailed data about one battery service or station when the appropriate station key is pressed. For example, during a service in Station 2, press **2** to see the following display:

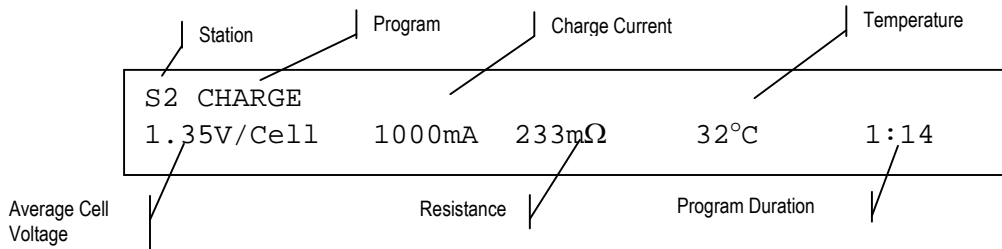

Note Press **▲** or **▼** to display additional details such as warning codes, cycles, and program phases.

- The Menu Display provides access to various functions of the analyzer when the MENU key is pressed (see *Menu Structure*, page 16).

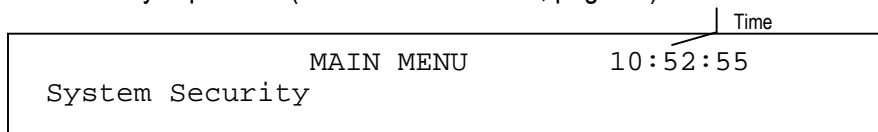

Press the MENU key and select menu functions by pressing **▲** or **▼** to scroll through the menu and pressing ENTER when the desired function is displayed. For example, this message shows one option in the System Security menu:

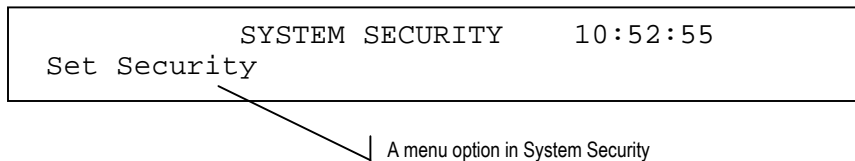

Lights (LEDs)

Light	Status	Explanation
RUN (yellow)	On	Service in progress.
READY (green)	On	Service has completed; Battery has passed the service.
	Flashing	Cold battery. Service resumes when battery warms up (code 12).
FAIL (red)	On	Battery failed.
	Flashing	Hot battery. Service resumes when battery cools (code 13).
All	Flashing randomly	System failed. Turn the analyzer off and then on. Contact Cadex if the condition persists.

Menu Structure

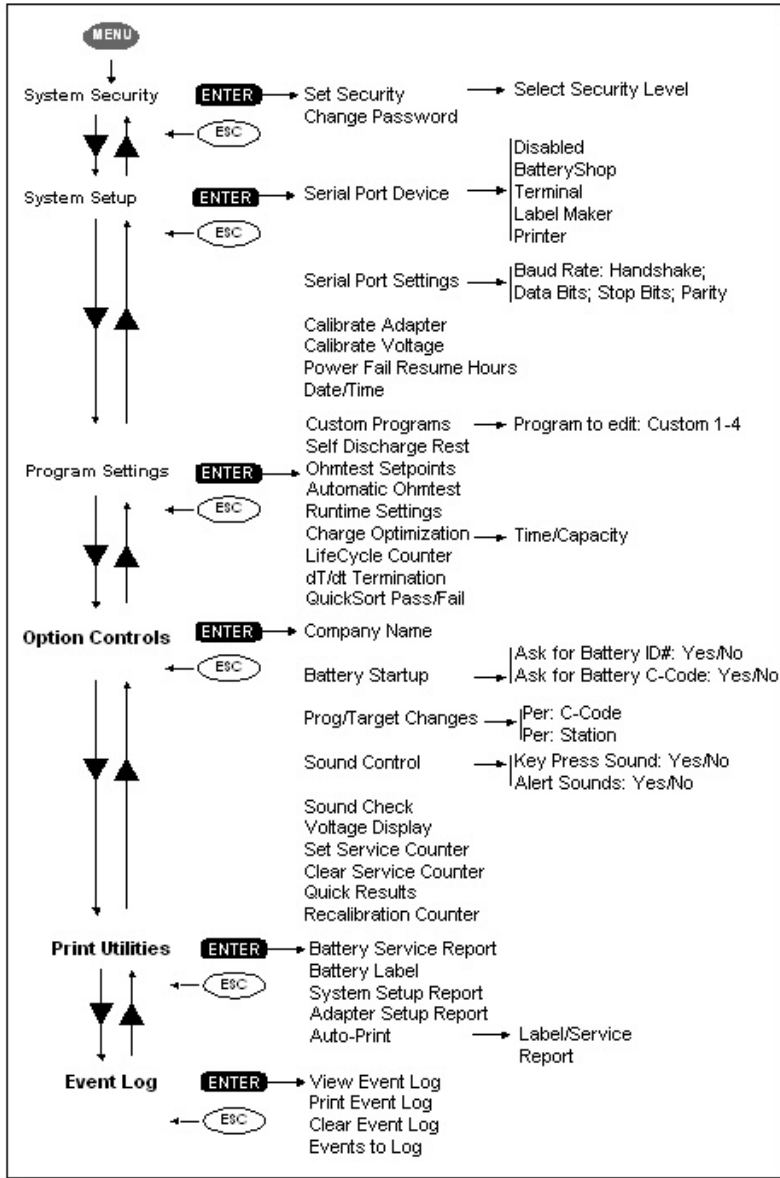

Figure 4: Menu hierarchy of the Cadex Analyzer (see chapters 7 to 10 for details)

Battery Adapters

Adapters are designed to fit specific battery types and shapes. The snap-lock latch allows easy insertion and removal. There are two types of Battery Adapters:

- **Custom Adapters** accommodate a specific battery shape. There are over 1000 custom adapters available.
- **Universal Adapters** are used when a custom adapter is not available. Pins or alligator clips attach to the positive and negative terminals and include a magnetic temperature sensor.

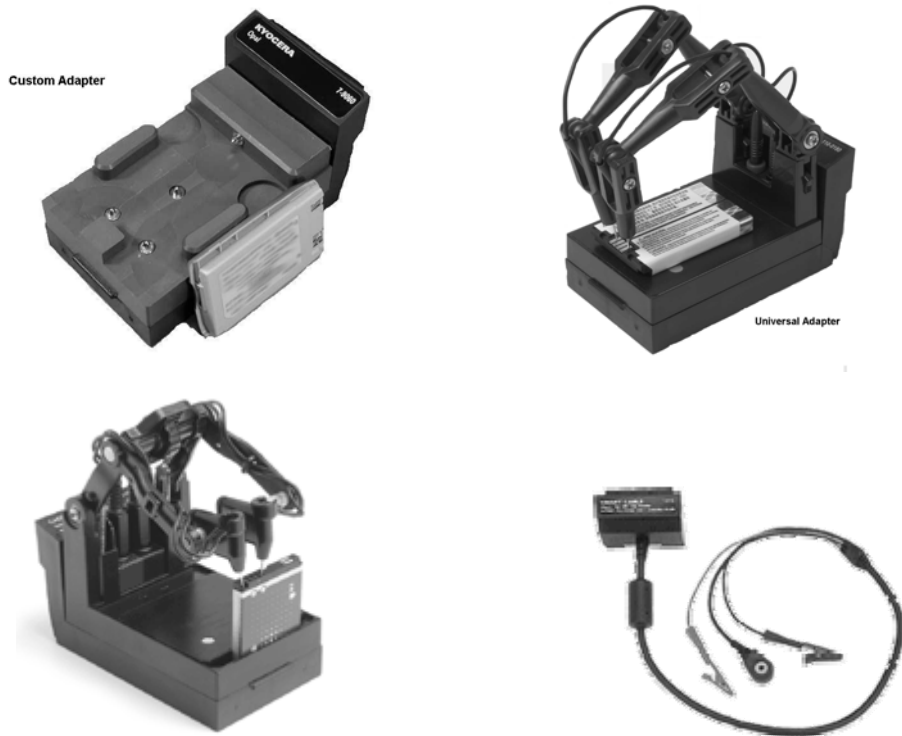

Figure 5: Different types of Battery Adapters (Clockwise from the top left): Custom Adapters for specific battery models, FlexArm 07-110-0180, Smart Cable 07-110-0115, RigidArm 07-110-0190.



ADAPTER HANDLING PRECAUTIONS

- Do not touch the adapter's gold contacts at the rear or on the analyzer station adapter connector. The static charge can damage microcircuits on the adapter.
- Do not remove the adapter from the analyzer while it is servicing a battery. Remove the battery first and then the adapter.
- ESD HANDLING PRECAUTIONS: When the adapter is NOT installed in analyzer:
- The battery should not be connected to the adapter
- Do not allow anything to touch the gold fingers on the adapter connector card
- Do not allow anything to touch the adapter connector in the analyzer's adapter well

Each adapter contains up to ten battery service parameters called Configuration Codes (or *C-codes*) in non-volatile memory. C-codes will not be lost when adapters are removed and reinserted into any station on the analyzer or when the analyzer is turned off.

Custom adapters are pre-programmed with C-codes for the most common batteries. If a battery C-code is not available, program a new C-code or reprogram an existing C-code into the analyzer.

Universal adapters, designed for generic batteries, are programmed with blank C-codes and will display NULL CODE when inserted (see *Create or Edit a C-code*, page 62). Battery Adapters can be installed, removed or reprogrammed while other stations are being used. Once the adapter is inserted, the battery station receiving the adapter automatically uses the last selected C-code.

Cadex continuously designs and manufactures adapters for new battery models. A list of current Battery Adapter models is available in the adapter catalog available in print or on the Cadex website. Contact Cadex for a current adapter catalog or download a copy from our web site at www.cadex.com. Cadex also designs custom adapters for a wide variety of applications. A Battery Adapter Design Form can be downloaded from the Cadex website and used to order a custom adapter.

To insert an adapter

1. Place the empty Battery Adapter into the Battery Adapter station, putting the front end in place first.
2. Press down on the back panel (with the label) until the adapter snaps in place.

The LCD display for the station changes from NO ADAPT to EMPTY, indicating that the Battery Adapter has been inserted but does not contain a battery. The second line of the display indicates the program that was selected in the C-code. If the adapter displays NULL CODE, the C-code has not been programmed, (see *Create or Edit a C-code*, page 62).



OBSERVE POLARITY! Do not connect the Universal adapter to the battery with the leads reversed or insert the battery into the adapter in reverse.

To remove an adapter

1. Remove the battery from the adapter first.
2. Press the latch bar behind the label on the adapter and lift the adapter upwards.

Chapter 4 Basic Battery Service

This chapter covers the basic procedures for servicing a battery including: turning on the unit; inserting the Battery Adapter; selecting the correct C-code and program; inserting the battery; confirming the setting; starting service and recording the results.

To service a battery

1. Turn the power on using the ON/OFF power switch on the rear panel. A boot-up screen appears for 5 seconds: It displays the firmware version on the bottom left (in this case, it is V1.00) and the security level (in this case, it has not been set). This screen can also be cleared after 5 seconds by pressing the ESC key.

```
C7400-C (C)2006 CADEX ELECTRONIICS INC.  
V1.00/1.00 ** DIAGNOSTICS PASSED **
```

2. Insert the Battery Adapter into a station by sliding the lower-front part of the adapter into the station towards the display. Press the back end down to close with a click. If adapters are inserted in Stations 1 and 4, a display like this appears:

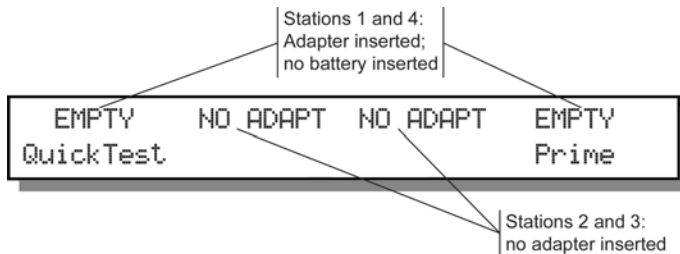

If a Universal adapter is used for the first time, NULL CODE appears on the display. Create a custom C-code (see *Create or Edit a C-code*, page 62).

3. Insert a battery into the adapter.



BATTERY CONTACTS MUST BE CLEAN BEFORE INSERTING THE BATTERY. Dirty contacts can increase the resistance in the connection between the adapter and the battery, causing false voltage and current readings and in extreme cases, melting of the contacts. To clean the battery contacts, use a lint-free cotton swab dipped in 100% isopropyl alcohol.

The following message appears when the battery is detected:

```
S1 Press ENTER and verify settings,  
then ENTER again to START
```

| Station number

Note The analyzer can be setup not to display this message and start service (see *Starting Battery Service*, page 77).

If the display continues to display an Empty message, this means that the Cadex analyzer is not recognizing the battery. There are a number of reasons this may happen:

Battery is not inserted correctly. Verify that the battery is correctly and firmly inserted into the adapter. Make sure that the contacts on the battery connect with the contacts on the adapter and check for any switches on the battery.

Battery is completely discharged or protection circuits are open. Run the Boost program by pressing the station key and holding it for two seconds (see *Boost*, page 38).

4. Press ENTER to display the C-codes (see Chapter 6 - *C-codes (Configuration Codes)*, page 47).

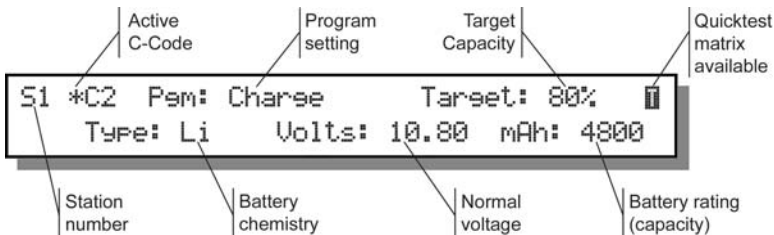

5. If the active C-code (indicated by “*”) is the correct one for the battery being serviced, go to step 2 otherwise continue to the next step.

6. Select another C-code.

Press ▲ or ▼ to scroll through the C-codes in the adapter.

Press ENTER when the correct C-code is displayed. Press ENTER again to confirm the changes. The selected C-code is now active, and is indicated by “*”.

To change any of the settings in the C-code, do it now (see *Create or Edit a C-code*, page 62).



Always use the correct C-code, especially the correct chemistry. Failure to do so may damage the battery or cause fire or explosion.

1. If the C-code is correct, press ENTER to confirm the settings.

2. Press ENTER again to start the battery service. The yellow (run) light appears.

Once the service starts, the display will show the current program status as in the following diagram. For detailed information about messages that appear, (see *Appendix A - Messages and Warnings*, page 123).

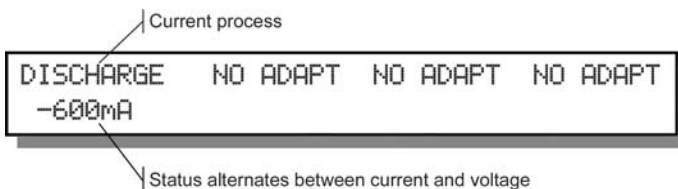

Depending on the battery chemistry and the program selected, service may take anywhere from a few seconds to a few hours. Some programs can take several days or weeks.

If the battery passes, the green Ready light comes on. If a battery failed, the red Fail light appears with a Fail code (see *Appendix A - Messages and Warnings*, page 123):

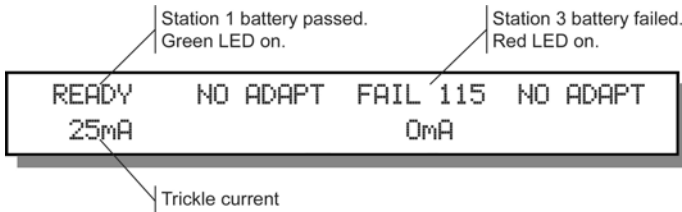

- To display details about an ongoing or completed battery service, press the station key to see the detailed display:

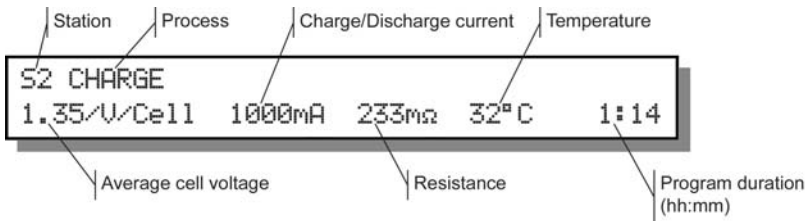

Press ▼ to see any applicable warning codes:

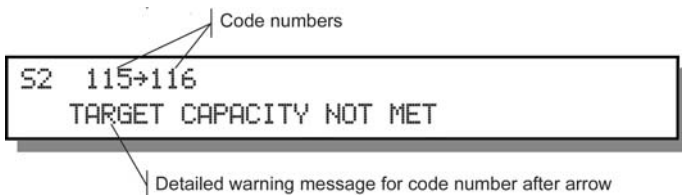

For more information about message codes, including reasons for battery failure and possible solutions, refer to Appendix A, *Messages and Warnings*, page 123.

Press ▼ to see additional information:

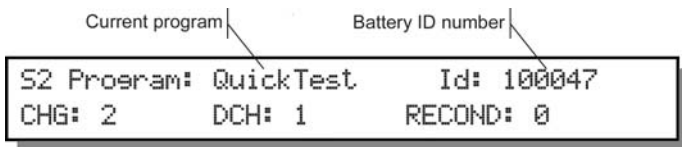

Bottom line shows number of charge, discharge, and recondition cycles run.



REMOVING LARGE BATTERIES WHILE IN SERVICE

It is NOT recommended to remove large batteries in service especially on the C7400ER. Large batteries may create arcs that will degrade the performance of the analyzer. Follow these instructions:

Press and release the Alt key and the station key that has the battery. On the screen that appears, press ▼ to select 'Interrupt' and press Enter. Remove the battery within 5 seconds.

Chapter 5 Battery Service Programs

The Cadex analyzer comes with four basic programs, nine advanced programs and four custom programs. These programs measure the battery state-of-health (SoH), the battery's capacity and find any anomalies that may affect battery performance. If the battery passes the Auto, Prime or Charge service programs, the battery can stay on the charger and stay fully charged until it is used. If the battery fails, the program terminates with the appropriate fault code.

Basic Programs

The basic programs are Auto, Charge, Prime, and QuickSort (for 16K Battery Adapters only). These programs cannot be edited. Each program performs functions for different purposes:

Program	Does this	Is used for this
Auto	Exercises batteries to maintain optimum performance. If the Target Capacity cannot be reached, the battery is reconditioned.	<ul style="list-style-type: none">• Restoring batteries affected by "memory".• Performing routine battery maintenance.• Identifying marginally performing batteries.• Servicing batteries in unknown condition.• Verifying battery condition for warranty claim.
Charge	Applies fast charge only. No capacity readings are taken and no discharge is applied.	<ul style="list-style-type: none">• Charging batteries quickly.• Topping up partially discharged batteries.

Program	Does this	Is used for this
Prime	Repeatedly cycles battery until maximum capacity is reached. If capacity improvement is more than 5% over previous reading, an additional cycle is applied.	<ul style="list-style-type: none"> • Preparing new batteries for field use. • Conditioning batteries that have been in storage.
QuickSort	Estimates battery capacity using an inference algorithm. For Li-Ion, 3.6V, 500 – 1500mAh 16K Battery Adapters only (adapters are identified with a “16K” sticker on the back)	<ul style="list-style-type: none"> • To rapidly sort batteries. • A ‘universal’ rapid test for Li-Ion batteries. • Can be used with the FlexArm 07-110-0180 or RigidArm 07-110-0190

Auto

Function: Exercises batteries to maintain optimum performance. This is the recommended program for routine maintenance of batteries. It reconditions NiCd and NiMH batteries that do not reach Target Capacity. Li-ion, Li-Ph and SLA batteries are not reconditioned, only exercised. Batteries in use are typically cycled every three months on Auto. If batteries are failing prematurely, increase the frequency of service on the Auto program.

Sequence: The battery is first cycled (charged and then discharged) to determine it’s true capacity. If NiCd and NiMH batteries do not meet the target capacity at the end of the discharge cycle, they are reconditioned to reduce battery memory. Following recondition, the battery is cycled again to determine the recovered or final capacity. The battery is fully charged when the program completes.

SLA, Li-ion and Li-Ph batteries are cycled once. If the target capacity is not reached in the first cycle, it is cycled again. Recondition is not performed for Li-ion, Li-Ph and SLA batteries.

Results: Global display shows battery capacity as a percentage of manufacturers stated capacity for the battery model. Detailed display shows average battery or cell voltage, analyzer charge or discharge current in mA, OhmTest results, battery temperature (if applicable), and duration of service

Batteries in good condition should be greater than the target capacity (by default this is 80%). If batteries fail, check the fault codes for details.

Duration: Approximately 2.5 to 10 hours for NiCd and NiMH, 20 to 40 hours for SLA and 6 to 20 hours for Li-ion & Li-Ph using default C-codes.

Charge

Function: Fast charge a battery.

Sequence: A charge cycle is applied to the battery. No capacity readings are taken (capacity is only obtained if there is a discharge). *Charge does not perform a diagnosis; use the Auto or Prime program to fully diagnose a battery.*

Results: The global display alternates between current average battery, cell voltage and analyzer charge or discharge current (mA) during service and after service. Detailed display also shows OhmTest results, battery temperature (if applicable) and duration of service.

Look for the green Ready LED. It indicates that the battery has been charged. There is no capacity reading taken during a charge. To diagnose faulty batteries the user is required to run Prime, Auto, etc.

Duration: Approximately 1.5 hours for NiCd and NiMH, 10 hours for SLA, and 4 hours for Li-ion & Li-Ph using default C-codes.

Prime

Function: Prepares new or stored batteries for use. A new or stored battery may require several charge/discharge cycles to form the cells to achieve peak performance.

Sequence: The program cycles (discharges and charges) the battery until the difference between capacities from one cycle to the next is less than 5%. Up to four cycles are applied until the 5% capacity difference is reached. This allows for batteries that cannot accept a full charge on the first cycle. If the battery is fully discharged, the program starts with a charge. No reconditioning is applied. Some batteries may require several Prime cycles to fully form the cells.

Results: Global display shows final battery capacity percentage. Detailed display shows battery capacity percentages for the last three cycles performed as well as average battery or cell voltage, analyzer charge or discharge current in mA, OhmTest results, battery temperature (if applicable) and duration of service.

Batteries in good condition should be greater than 80% or the target capacity. If batteries fail, check the fault codes for details. If the capacity is low, the battery should be Primed again. In some cases, two or three Prime programs may be required to fully form a battery.

Duration: Approximately 5 to 10 hours for NiCd and NiMH, from 40 to 80 hours for SLA, from 12 to 25 hours for Li-ion & Li-Ph using default C-codes.

QuickSort

Notes: QuickSort is available only on 16k Battery Adapters. These adapters are marked with a '16K' label on the rear of the adapter. The QuickSort program can be selected only when the Li-ion C-code is selected.

The battery must have at least 40% State-of-charge. Charge a battery fully if you are unsure of the battery's State-of-charge.

Function: This program works for single cell Li-ion, 3.6V, and 500mA to 1500mAh batteries and with the FlexArm (07-110-0180) and RigidArm (07-110-0190) adapters.

Sequence: QuickSort consists of several test pulses including an OhmTest. An approximation to the battery's condition is then calculated. There is no maintenance charge after this program is completed.

Results: The Global and detailed display shows the battery condition as “Good”, “Low” or “Poor”. Detailed display also shows average battery or cell voltage, analyzer charge or discharge current in mA, OhmTest results, battery temperature and duration of service.

Duration: 30 seconds.

Advanced Programs

Advanced programs include OhmTest; Runtime; Self-Discharge; Life-Cycling; Discharge Only; Extended Prime; Q-Learn (QuickLearn); Learn; Boost and the four programmable custom programs. Unlike basic programs, some advanced programs have settings that can be edited.

Program	Does this	Is used for this
Self-Discharge	Reads fully charged battery capacity; recharges and reads the capacity after a programmable wait period.	Identifying batteries that may have good capacity but have high self-discharge.
Life-Cycle	A destructive test: Continuously cycles battery until capacity drops below target capacity. Displays initial and final capacity, OhmTest result.	Verifying battery life cycle. For example, take a sample of batteries to determine the Life Cycle of an entire batch of batteries. Estimating performance time.
Discharge Only (DCHOnly)	Discharges a battery to its end-of-discharge voltage.	Determining residual capacity of battery. Preparing batteries for storage. Determining battery performance under load.
Extended Prime	Applies a 16-hour trickle charge, followed by cycling to obtain peak capacity.	Preparing new batteries or batteries that have been in extended storage for use.
OhmTest	Tests internal resistance. Passes or fails the battery based on the target resistance.	Checking battery condition. Determining if the battery needs to be analyzed further.
Runtime	Simulates field application with three adjustable load currents and time intervals.	Testing battery runtime for various equipment.

Program	Does this	Is used for this
Boost	Applies a 100mA trickle charge for 3 minutes.	Reactivating batteries that are not recognized by the Cadex analyzer because of low voltage or an open protection circuit.
Q-Learn (QuickLearn)	This program assumes that a battery has 100% capacity. It profiles the battery and saves the data to the QuickTest™ matrix in the C-code.	Rapidly establishing an accurate QuickTest™ matrix based on the SoH of a new battery that is known to be good.
Learn	Applies a charge-discharge-charge cycle to determine battery capacity, profiles the battery, saves the data to the QuickTest™ matrix in the C-code.	Establishing or modifying QuickTest™ matrix using a spectrum of batteries with various SoH. Increasing QuickTest™ accuracy (confidence grade) for a given battery type.
QuickTest™	Tests battery SoH by comparing battery data to data from other batteries of the same model stored in the QuickTest™ matrix in the C-code.	Gives an estimate of battery SoH to help sort batteries. A matrix is required to run this program (see <i>Q-Learn Procedure</i> , page 43).
Custom 1,2,3,4	Allows the user to create specific programs (see Chapter 10 - <i>Custom Programs</i> , page 100).	Accommodates specialized requirements.

SelfDCH (Self-Discharge Test)

Function: Identifies the self-discharge or the amount of charge a battery loses if it is left alone for a period of time. The standard time is 24 hours.

Sequence: The battery is charged and discharged to obtain its first capacity. The battery is then charged and left for a 24-hour rest period (instructions to change this

time are given below). During this time, the battery loses energy through self-discharge. After 24 hours, the battery is discharged to determine the second capacity. The difference between the second and first capacity is the self-discharge.

Results: Press the station key to view the detailed display then press \blacktriangle to view the self-discharge rate (given as a percentage). A battery with low self-discharge has less than 15% self-discharge. A battery that has more than 15% self-discharge may have soft cells and may not be able to provide the required use-time.

Global display shows battery capacity percentage. Detailed display shows battery capacity percentages for the last three cycles performed. It also displays average battery or cell voltage; analyzer charge or discharge; current in mA; OhmTest results; battery temperature and duration of service.

Duration: Approximately 30 hours for a NiCd battery using default C-codes.

To change the Self-Discharge time

1. From the global display, press MENU.
2. Press \blacktriangle or \blacktriangledown to scroll to PROGRAM SETTINGS, then press ENTER.
3. Press \blacktriangle or \blacktriangledown to scroll to SELF-DISCHARGE REST, then press ENTER.
4. Press \blacktriangle or \blacktriangledown or use the number pad to select the self-discharge period.
5. Press ENTER.
6. Press \blacktriangle or \blacktriangledown to scroll to YES to accept changes and press ENTER.
7. Press ESC twice to return to the global display.

Life-Cycle



This is a “destructive” test that continuously cycles a battery until it fails. Do not run this program on a battery that need to be used after the program completes.

Function: Determines total battery life by the number of cycles. Checks whether the battery meets the standard life for its chemistry. This is an accelerated aging test and the battery cannot be renewed after this test.

Sequence: The battery is charged and discharged continuously until the battery fails (i.e. battery capacity falls below target capacity) or the maximum number of cycles has been reached.

Results: Global display shows failure-warning message. Detailed display shows percentage capacity for the first cycle and the last three cycles run. It also displays: average battery or cell voltage; analyzer charge or discharge current (shown in mA); OhmTest results; battery temperature and duration of service.

An additional display screen (press ▲ from detailed display) shows cycle number, percentage of battery capacity achieved and OhmTest results for the first and last cycles run.

Look for the number of cycles (a cycle is a charge followed by a discharge). Batteries should provide the number of cycles as specified by the manufacturer. Typically, with a target capacity of 80%, NiCd batteries should provide about 1500 cycles, NiMH 500 cycles, Li-ion & Li-Ph 500 cycles, and SLA 300 cycles.

Duration: Approximately one month or more depending on the chemistry.

To edit the Life Cycle Test settings

The program uses the target capacity set in the C-code to determine when the program should end (see *Target Capacity*, page 49). To terminate the program after a certain number of cycles, do the following:

1. From the global display, press MENU.
2. Press ▲ or ▼ to scroll to PROGRAM SETTINGS, then press ENTER.
3. Press ▲ or ▼ to scroll to LIFECYCLE COUNTER, then press ENTER.
4. Press ▲ or ▼ or use the number pad to select the number of cycles.
5. Press ENTER. Press ▲ or ▼ scroll to YES to accept changes and press ENTER.

6. Press ESC twice to return to the global display.

DCHOnly (Discharge Only)

Function: The DCHOnly program determines the residual capacity of a battery, prepares batteries for storage and checks battery performance under load.

To determine battery capacity, fully charge the battery using the Charge program before running the Discharge only program.

Sequence: The battery is discharged until its voltage reaches the END-OF-DISCHARGE setting in the C-code.

Results: Detailed display shows battery capacity as a percentage of manufacturer's stated capacity for the battery model. It also shows average battery or cell voltage, analyzer charge or discharge current (in mA), battery temperature and duration of service. Look for the green ready LED. The battery capacity is measured during a discharge and if the battery is partially discharged, the capacity may be lower than the target capacity. This may give a Fail Code 115 or 116. The battery is not necessarily poor.

Duration: Approximately 1 hour for a NiCd battery discharged at default C-code settings.

To edit the Discharge Only settings

The Discharge Only test settings cannot be edited. However, the program uses the END-OF-DISCHARGE setting in the C-code (see *Error! Reference source not found.*, page *Error! Bookmark not defined.*).



Smart batteries (often used in laptops) should not be stored in a fully discharged state. If the battery's voltage drops below the level required by the processor within the battery, information can be lost. In some cases, this data loss can leave the battery permanently unusable.

ExtPrime (Extended Prime)

Function: Exercises a battery that has been in storage or unused for three months or more.

Sequence: The battery is charged for 16 hours on the TRICKLE CHARGE setting in the C-code. The battery is then continually cycled (charged and discharged) up to five times until the difference between the capacities achieved from one cycle to the next is less than 5%.

Results: Global display shows final battery capacity percentage. Detailed display shows battery capacity percentages for the last three cycles performed. It also shows average battery or cell voltage; analyzer charge or discharge current (in mA); OhmTest results; battery temperature and duration of service.

Batteries in good condition should be greater than 80% of the target capacity. If batteries fail, check the fault codes for details. If the capacity is low, the battery should be Primed again. In some cases, two or three Prime programs may be required to fully form a battery.

Duration: Approximately 24 hours for a NiCd battery charged and discharged at 1.00 C.

OhmTest



OhmTest uses a method similar to the IEC "DC" method to determine the battery resistance. The results tend to be higher than analyzers with firmware version 5.00 and below. Therefore, the OhmTest results cannot be compared with results from analyzers with older firmware versions.

Ensure that battery contacts and adapter contacts are clean. Dirty contacts will affect OhmTest readings.

Function: This program is similar to the IEC "DC" method of resistance measurement. It is recommended that the battery have a high state-of-charge (i.e. fully charged) to provide values. If battery SoC is less than 50%, OhmTest readings

are less consistent. Low state-of-charge may produce poor or low values. The OhmTest program determines the internal resistance of a battery and passes or fails the battery based on the OHMTEST SETPOINTS. It provides an estimate of the battery capability to handle load. Setting an OHMTEST SETPOINT is described below.

Sequence: The program tests battery resistance and compares the result with the analyzer's OHMTEST SETPOINTS for the battery chemistry. If the result is above this threshold, the program fails the battery.

Results: Global display shows internal resistance in milliohms (mΩ). Detailed display also shows average cell voltage; analyzer charge or discharge current (in mA); battery temperature and duration of service.

If the value is above the analyzer's OhmTest setpoint threshold, the battery fails the OhmTest and should be replaced. If the battery passes, run the Auto or Prime program on the battery to determine whether there are other faults.

Compare several good and bad batteries to determine a suitable OHMTEST SETPOINT.

Duration: 15 seconds for all chemistries.

To edit the OhmTest Setpoint

1. From the global display, press MENU.
2. Press ▲ or ▼ to scroll to PROGRAM SETTINGS and then press ENTER.
3. Press ▲ or ▼ to scroll to OHMTEST SETPOINTS and then press ENTER.
4. Press ▲ or ▼ or use the number pad to set the OhmTest setpoint for the first battery chemistry type.

The default setpoint is 1000mΩ but any setting between 0 and 4000mΩ can be chosen.

5. Press ◀ or ▶ to move to the next battery chemistry type.
6. Repeat steps 4 and 5 until the OhmTest setpoint for all battery chemistries are set appropriately.

7. Press ENTER.
8. Press ▲ or ▼ to scroll to YES to accept changes and press ENTER.
9. Press ESC twice to return to the global display.

Runtime

Function: The Runtime program simulates field application with three adjustable load currents and time intervals.

Sequence: The battery is charged. The program then repeatedly runs three different loads (see instructions below to set these loads) until the battery is fully discharged (i.e. The end-of-discharge setting in the C-code is reached).

Results: The detailed display shows the battery run-time (hours and minutes). It also shows battery or cell voltage; analyzer charge or discharge current (in mA); OhmTest results; battery temperature and duration of service.

Duration: Approximately 8 – 10 hours for a NiCd battery using default C-codes.

To edit the Runtime settings

1. From the global display, press MENU.
2. Press ▲ or ▼ to scroll to PROGRAM SETTINGS and then press ENTER.
3. Press ▲ or ▼ to scroll to RUNTIME SETTINGS and then press ENTER.
4. The cursor is at Discharge 1 (the first load).
5. Press ▲ or ▼ or use the number pad to set a load between 1 and 100 for the Discharge %. This is a percentage of the Discharge Rate in the C-code. The default is 100.
6. Press ▶ to move to Minutes – the time this load is applied. Press ▲ or ▼ or use the number pad to set the time between 1 and 59 minutes. The default is 1.
7. Press ▶ to move to the load setting for the Discharge 2 (second phase). Repeat steps 4 and 5.

8. Press **▶** to move to the load setting for the Discharge 3 (third phase). Repeat steps 4 and 5.
9. Press **ENTER** to save the settings.
10. Press **▲** or **▼** to scroll to **YES** to accept changes and press **ENTER**.
11. Press **ESC** twice to return to the global display.

Boost



Warning! The Boost program overrides some of the analyzer's built-in safety measures to recognize a battery. Do not attempt to Boost a battery if the polarity, chemistry, voltage and capacity (mAh) are not known.

Failure to follow these precautions may result in serious damage to the Cadex unit and/or the battery.

Ensure that battery polarity is correct before attempting to run Boost. For this reason, it is **NOT** recommended to use a Universal Adapters (07-110-0115, 07-110-0180 or 07-110-0190) with Boost.

Function: Reactivates batteries with open protection circuits or with a very low voltage that the Cadex analyzer does not recognize it or gives a 'Shorted' (Code 121) message.

Sequence: The battery is trickle-charged for three minutes at 100mA. The Program can be terminated at any time by pressing the Esc key. Look for stable current and voltage readings during the Boost program. If they are intermittent, the battery may be poorly connected, battery protection circuit may be damaged or the battery is inoperable. Normal battery service will start after Boost has reached more than 0.30V/cell on NiCd and NiMH batteries and more than 2.5V for Li-ion and 1.90V for Li-Ph batteries. If Boost does not raise the voltage to detectable levels, apply the Boost program again.

Results: If the Boost is successful, the Cadex analyzer recognizes the battery and indicates on the global display that a battery is inserted in the Battery Adapter.

Duration: 3 minutes (user may repeat if unsuccessful).

To run the Boost program

1. Insert the Battery Adapter in a battery station.
2. Insert the battery in the Battery Adapter.

If the battery needs to be boosted, the global display for the station may show one of two things:

- i. It may continue to display the EMPTY message, indicating that the Cadex analyzer has not recognized the battery.
 - ii. It may display a SHORTED (Code 121) message for the battery.
3. Press the station key and hold until a warning message appears to check battery polarity (about 2 seconds).
4. If polarity is correct, press ENTER to start Boost. Depending on how the analyzer is set up (see *To verify C-code or enter Battery ID before battery service begins*, page 77), press ENTER again to accept the C-code settings and start Boost.
5. The program runs for 3 minutes and provides a 100mA charge.
6. Press ESC any time during the Boost to terminate the program.
7. If the Boost is successful, the global display changes to the active program name to show that the Cadex analyzer now recognizes the battery. If the analyzer does not recognize the battery, remove and reinsert the battery and the adapter.
8. If the Boost is unsuccessful, repeat this procedure until it is successful or until you are convinced that the battery cannot be restored.

To edit the Boost settings

The Boost test program has no settings that can be edited. Boost current is fixed at 100mA for three minutes.

Learn



C7000 C-series firmware will not display a matrix made with C7000 series firmware. Therefore, run the Learn program again to create a new matrix.

Ensure that battery contacts and adapter contacts are clean. Dirty contacts will affect QuickTest readings.

Function: Learn creates and stores a matrix in a C-code for use by QuickTest.

Sequence: The Learn program applies several charges, discharges and OhmTest to obtain a battery profile called a matrix. This matrix is automatically stored in the C-code.

Results: Detailed display shows three decreasing capacity percentages as well as average cell voltage; analyzer charge or discharge current (in mA); OhmTest results; battery temperature and duration of service. The C-code display screen shows a T in the upper right-hand corner to indicate that a C-code, saved as a matrix, has been stored for using with the QuickTest program.

Duration: 4 – 8 hours depending on battery capacity and default C-codes.

Learn Limitations

Learn is available only on 16K Battery Adapters. '16K' is marked on the rear label of the adapter.

Only custom adapters should be used. Universal adapters such as the Universal Alligator Clips Adapter (07-110-0115), the RigidArm (07-110-0190) and the FlexArm (07-110-0180) are NOT recommended. These adapters create inaccurate results due to resistance errors.

Learn and QuickTest cannot be used with the following batteries:

- SLA batteries greater than 2Ah (2000mAh).
- Some 1-cell (1.20V) and 2-cell (2.40V) NiCd and NiMH batteries.

- Batteries with resistance above 800mΩ (as measured by OhmTest). It is advisable to run an OhmTest to determine battery resistance prior to running the Learn program.
- Batteries that disconnect, reset or give failures while running the Learn program.
- Batteries that cannot accept a charge rate and discharge rate of at least 1.00C. These batteries tend to give errors if they are serviced on the analyzer using the Auto or Prime programs.

Learn Procedure

Calibrate the adapter and ensure that the C-code for the battery is correct. Take a good battery (over 80% capacity) and run through the Learn program. After the Learn program is complete, take the battery and while it is in the same adapter, run the QuickTest program. The final SoH (state-of-health) result should be within the range of the actual battery capacity. If not, erase the battery matrix (press FN and then press 2) and start over. Once successful, test other batteries with the same capacity, if possible, to ensure that the SoH readings are within an acceptable range.

To create the most effective matrix, repeat the above steps with more batteries. It is recommended to run the Learn program on at least three batteries: one with a capacity above 90%; one with a 70-80% capacity and finally one at 70% capacity. The batteries can be run through the Learn program in any order.

The battery matrix will be erased if anything in the C-code is changed except for the target capacity and the actual program (i.e Auto, Charge, Prime, QuickTest or any of the other programs).

Q-Learn (QuickLearn)

Function: Q-Learn creates and stores a matrix in a C-code for use by QuickTest. The Q-Learn program is only run once on a battery. For more accurate results, use the Learn program instead.

Sequence: This program assumes that the battery has 100% capacity. If a battery has lower capacity, it will not make a correct matrix. The program consists of a charge and a discharge and the OhmTest. The data obtained from the program profiles the battery's SoH (called a matrix) and automatically stores it with the battery C-code.

Results: Detailed display shows the battery's average cell voltage; analyzer charge or discharge current (in mA); OhmTest results; battery temperature and duration of service. If Q-Learn is successful, the C-code will display a T in the upper right-hand corner to indicate that a QuickTest matrix has been created.

Duration: Approximately 5 minutes for all batteries with a SoC (state-of-charge) level between 20% and 90% of battery capacity. Batteries with a SoC level lower than 20% or greater than 90% require additional time to bring their SoC to between 20% and 90%. For most batteries, this takes an additional 5 minutes but in some cases, especially with high-capacity batteries, it may take longer.

Q-Learn Limitations:

Use Q-Learn:

- a. if the battery's capacity is 100%. If a battery's capacity is less than 100%, it will give erroneous results.
- b. If the battery has been used (ie. excited) in the last 24 hours.
- c. On custom adapters only. Universal adapters such as the Universal Alligator Clips Adapter (07-110-0115), the RigidArm (07-110-0190) and the FlexArm (07-110-0180) are NOT recommended. These adapters will give inaccurate results due to resistance errors.

Q-Learn should only be used once. For more accurate results, run the Learn program on three different batteries with varying capacities.

Q-Learn is available only on 16K Battery Adapters. '16K' is marked on the rear label of the adapter.

Q-Learn and QuickTest cannot be used with the following batteries:

- SLA batteries greater than 2Ah (2000mAh).
- 1-cell (1.20V) and 2-cell (2.40V) NiCd and NiMH batteries.
- Batteries with resistance above 800mΩ (as measured by OhmTest). It is advisable to run OhmTest on any battery that is run through the Q-Learn program.
- Batteries that disconnect, reset or give failures while running the Learn or Q-Learn programs.
- Batteries that cannot accept a charge rate and discharge rate of at least 1.00C. These batteries tend to give errors if they are serviced on the analyzer using the Auto or Prime programs.

Q-Learn Procedure

Calibrate the adapter and ensure that the C-code for the battery is correct. Take several batteries with 100% capacity or over. Confirm the capacity by servicing the batteries on the Prime program. Note the final capacity and resistance readings. Take the battery with the highest capacity (ensure that it is 100% or greater) and the highest resistance and run this battery through the Q-Learn program. After the Q-Learn program is complete, take the same battery in the same adapter and run it through the QuickTest program. The final SoH (state-of-health) result should be 100%. If the result is less than 100%, erase the battery matrix (press FN and then press 2) and start over. When a successful result has been obtained (100%), test the other batteries with the same capacity to ensure that the SoH readings are within an acceptable range.

The battery matrix will be erased if anything in the C-code is changed except for the target capacity and the actual program (i.e Auto, Charge, Prime, QuickTest or any of the other programs).

QuickTest™



C7000 C-series firmware will not display a matrix made with C7000 series firmware. Therefore, run the Learn program again to create a new matrix.

Ensure that battery contacts and adapter contacts are clean. Dirty contacts will affect QuickTest readings.

Note: QuickTest is available only when using 16k Battery Adapters. These adapters are marked '16K' on the rear of the adapter.

QuickTest matrices created by the Q-Learn and the Learn programs are stored in Battery Adapters as part of the C-code and can be copied to other adapters. However, any change made to the C-code (except target capacity and selected program) erases the stored QuickTest matrix.

Function: Before running QuickTest, create a matrix for the battery using the Learn program (see *Learn*, page 40). QuickTest determines the battery SoH (state-of-health) that is an approximation of the battery capacity and resistance. If a matrix does not exist for the C-code, (i.e. no batteries of the same model have gone through the Q-Learn or Learn programs) a message appears stating that no QuickTest matrix has been found, and that the Learn program should be run first. QuickTest can still run without a matrix but results are unreliable.

Sequence: The battery is tested to ensure that it has 20% - 90% State-of-charge. If not, it applies a charge or discharge for five minutes. The program then performs a sequence of resistance tests, partial charges, discharges and rest. Test results are compared to the matrix to determine the battery state-of-health.

Results: The Global and detailed display shows the battery condition as "Excellent", "Good", "Marginal" or "Poor". Detailed display also shows average battery or cell voltage, analyzer charge or discharge current in mA, OhmTest results, battery temperature (if applicable) and duration of service.

Duration: Approximately 5 minutes if the battery SoC (state-of-charge) is between 20% and 90%. Batteries with a lower or higher SoC require additional time to bring

their SoC to between 20% and 90%. For most batteries, this takes about 5 minutes. However, with high-capacity batteries, it may take longer.

Custom 1, 2, 3, and 4

By default, custom programs are blank when the Cadex analyzer is shipped from the factory (see Chapter 10 - *Custom Programs*, page 100).

Battery Service Times

The following table displays the approximate service times at default charge and discharge rates.

	NiCd, NiMH	SLA	Li-ion & Li-Ph
Auto	2.5 – 10 hours	20 – 40 hours	6 – 20 hours
Charge	1.5 hours	10 hours	4 hours
Prime	5 – 10 hours	40 – 80 hours	12 – 25 hours
QuickSort	N/A	N/A	30 Seconds (Li-Ion Only). N/A for Li-Ph
OhmTest	15 seconds	15 seconds	15 seconds
Runtime	Duration depends on settings		
Self-Discharge	30 hours	60 hours	50 hours
LifeCycle	1500 cycles (NiCd) 500 cycles (NiMH)	200 – 500 cycles	1000 cycles
Discharge Only	1 hour	20 hours	4 hours
Extended Prime	21 – 26 hours	56 – 96 hours	28 – 41 hours
QuickTest	All chemistries: approximately 5 minutes		
Q-Learn (Quick Learn)	All chemistries: 2-5 minutes		
Learn	All chemistries: 4 – 8 hours		
Boost	All chemistries: 3 minutes		
Custom 1, 2, 3, 4	Duration depends on settings		

Chapter 6 C-codes (Configuration Codes)

The adapter requires the battery chemistry, voltage and rating in order to service a battery. This information is stored on the adapter as a *C-code*. Each adapter can hold 10 C-codes. Once a C-code has been entered, the information is stored permanently in the adapter memory where it can be displayed, selected, created, copied, edited and deleted (see *Managing C-codes*, page 61). The adapter can be moved between stations* and the C-code remains within the adapter.

Note A C-code cannot be edited or changed while a battery is serviced.

Custom Battery Adapters come pre-programmed with the most common battery C-codes compatible with the adapter. Universal adapters such as 07-110-0115 (Smart Cable), 07-110-0180 (FlexArm) and 07-110-0190 (RigidArm) are shipped with no C-codes and will display NULL CODE when inserted into the analyzer. Create a C-code to clear the NULL CODE message (see *Managing C-codes*, page 61).

Each C-code is divided into three parts:

- Basic C-codes include program; target capacity; chemistry; voltage and capacity. The C-code setup name, if specified, is displayed on the LCD screen along with basic parameters. If a C-code is locked, scaled or has a matrix, it is indicated on the display by an 'L', 'S' or 'T' respectively. The battery chemistry, voltage and capacity are required in order to start servicing a battery.
- An extended C-code, which consists of charge/discharge C-rate, trickle-charge rate, recondition settings and other parameters are needed to service a battery. The types of parameters depend on the battery chemistry described in the following table. In general, extended parameters can be left at their default settings.

* It is recommended to calibrate Battery Adapters whenever they are moved from one analyzer to another (see Adapter Calibration page 132).

- A matrix contains the battery C-code information for running the QuickTest program. Running the Learn or Q-Learn program produces the matrix. Matrix information cannot be seen on the analyzer, however, an inverse T in the top right hand corner of the LCD screen, when the Basic C-code is displayed, will indicate that a matrix has been stored. The matrix is deleted if any part of the C-code, apart from the target capacity or program and is changed (i.e. Auto, Charge, Prime, QuickTest or any of the other programs).
- An adapter can save up to 10 C-codes. Each C-code is unique and has the following characteristics:

C-code #	Basic C-code	Extended C-code	Matrix
C1	CC1	EEEE1	MMMMMMM1
C2	CC2	EEEE2	MMMMMMM2
C3	CC3	EEEE3	MMMMMMM3
C4	CC4	EEEE4	MMMMMMM4
C5	CC5	EEEE5	MMMMMMM5
C6	CC6	EEEE6	MMMMMMM6
C7	CC7	EEEE7	MMMMMMM7
C8	CC8	EEEE8	MMMMMMM8
C9	CC9	EEEE9	MMMMMMM9
C10	CC10	EEEE10	MMMMMMM10

Basic C-code Parameters

Basic C-code parameters appear on the first detailed screen whenever a Battery Adapter is inserted in a station and the station key is pressed.

Program

The Program parameter specifies which of the programs is to be run (see Battery Service Programs, page 25).

Target Capacity

The target capacity (displayed as TARGET on the analyzer LCD screen) is a pass/fail mark. Batteries must achieve the target capacity to pass service. In the Auto program, if a battery capacity is less than the Target Capacity, the battery is reconditioned.

The target capacity does not determine the level to which a battery is charged; it only provides an arbitrary point to which to compare actual battery capacity. For example, a battery with a 90% capacity will pass if the target capacity is set at 80% but fail if the target capacity is 100%. The batteries are always fully charged.

The target capacity can be set for 50% to 150% of nominal capacity. These values are recommended for most uses:

- 90% Maintains batteries for critical applications that require maximum energy reserve and high reliability. Fewer batteries will pass.
- 80% Recommended (default) setting that provides a balance between adequate energy reserve and long service life.**
- 70% Recommended for less stringent applications where battery power demand is not critical or is of brief duration. More batteries will pass.

Chemistry

The chemistry parameter refers to the battery chemistry. The chemistry is labeled on the battery. The analyzer works with: NiCd (Nickel-cadmium); NiMH (Nickel-metal-hydride); SLA (Sealed Lead Acid), Li-ion (Lithium-ion and Li-Polymer) and Li-Ph (Lithium Phosphate).

Battery Voltage (Volts)

The Battery Voltage parameter refers to the terminal voltage of the battery. The voltage is often labeled on the battery. The voltage is based on a nominal cell voltage of 1.2V/cell for NiCd and NiMH batteries, 2V/cell for SLA batteries, 3.6V/cell for Li-ion and 3.3V/cell for Li-Ph batteries.

C7200-C and C7400-C: The maximum voltage is 14.4V for NiCd, NiMH and Li-ion; 13.2V for Li-Ph batteries and 14V for SLA batteries. The C7200-C and C7400-C cannot be modified to handle batteries greater than 14.4V.

C7400ER-C: The maximum voltage is 28.8V for NiCd and NiMH, 36V for SLA and Li-ion, 26.4V for Li-Ph..

On some NiCd and NiMH batteries, manufacturers may rate the voltage based on 1.25V/cell rather than 1.2V/cell. For example, the batteries may have a stated voltage of 7.5V or 12.5V. To obtain the correct voltage, multiply this voltage by 0.96. These voltages are definitions only (in fact, battery voltage varies depending on the state-of-charge) and do not affect test results. Set the Cadex analyzer to display voltage as either 1.2V/cell or 1.25V/cell (see *Voltage Display*, page 69).

Some manufacturers may state the number of cells of their batteries. To get the correct voltage, multiply the number of cells by the chemistry type. For example, the voltage of a 6-cell NiCd would be $6 \times 1.2V = 7.2V$. Use 7.2V on the analyzer.

Battery Rating (mAh)

The battery rating is the nominal capacity or the capacity specified by the manufacturer. These are also indicated on the battery or may be obtained from the manufacturer.

If a battery rating is provided in Watt-Hours (Wh), divide it by the battery voltage to obtain the mAh rating. For example, a 5Wh battery is 0.7Ah (700mAh).

Available settings: 100 – 24,975mAh in increments of 25mAh.

C-code Setup Name

The C-code setup name might be the battery model number or some other name that helps users quickly identify the battery it defines. Use ALT-EDIT to access the C-code name and FN-0 to clear the text.

Scaled C-code

Due to the power limitations on the analyzer, if a C-code requires a higher charge or discharge rate than the analyzer is capable, it automatically scales the C-code. An inverse S on the top-right hand corner of LCD screen when the basic C-code is displayed will indicate a scaled C-code.

C-code Matrix

When a C-code matrix has been stored to perform a QuickTest, an inverse T in the top-right-hand corner of the LCD screen will display along with the basic C-code.

Locked C-code

Cadex locks some C-codes at the request of the battery manufacturer. An inverse L on the top-right hand corner of the basic C-code display indicates a locked C-code. These C-codes cannot be edited but they can be deleted.

Extended C-code Parameters

In general, extended C-code parameters can be left on their default settings. For servicing intrinsically safe (I/S) batteries or Hawker SLA batteries, pay close attention to the extended C-code parameter settings (see *Extended C-code Settings for Special cases*, page 57).

Charge Rate

A battery with 1000mAh capacity that is charged at 500mA has a charge rate of 0.50C (where C stands for capacity). A lower charge rate reduces the charge current and increases service time. Maximum current is 4000mA (6000mA for the C700ER) for batteries with a stated cell voltage of up to 7.2 V. Maximum current is reduced for batteries with higher nominal voltage. For example, on the C7200, the charge rate for a 14.4V battery will be automatically scaled to 2000mA. An inverse S (Scaled) will be displayed on the basic C-code screen.

Discharge Rate

A battery with 1000mAh capacity that is discharged at 500mA is discharged at 0.50C (where C stands for Capacity). A lower discharge rate reduces the discharge current and increases service time. Maximum current is 4000mA (6000mA for the C7400ER-C using special adapters). The discharge rate is reduced for batteries with higher nominal voltage (for example, 2400mA for a 14.4V battery on the C7200). For a single-cell NiCd or NiMH battery, the maximum discharge is 2500mA.

Default Charge and Discharge Rates

NiCd: Standard NiCd batteries up to 1800mAh can be charged and discharged at rate of 1.00C (C stands for capacity). Cadex recommends a C-rate of 0.70C or 0.50C for batteries above these mAh ratings. The default setting for NiCd is 1.00C. For 1.2V and 2.4V batteries, the default charge rate is 0.30C to maintain normal temperatures.

NiMH: NiMH batteries produce heat during Charge and Discharge. The default charge rate is 0.50C if Temperature Sensing is Disabled. In addition, due to the very fine negative slope, the current is cut in half twice towards the end of the charge cycle to ensure that the battery is fully charged (this current is not reduced if the Charge rate is at 0.10C). If temperature sensing is Disabled, a rest period is applied before the current is cut to allow for the battery to cool. This lengthens the service time. For 1.2V and 2.4V batteries, the default rate is 0.30C to maintain cooling. If the battery gets hot during charge, reduce the Charge rate to 1000mAh or less.

SLA: Battery manufacturers rate the SLA at a 20-hour discharge (0.05C). This slow discharge is not practical when analyzing SLA batteries so the analyzer uses a default 0.30C Charge and 0.10C (10-hour) discharge. Due to this higher discharge rate, the battery will give a lower capacity. Refer to the manufacturers specification for the battery rating at the 10-hour discharge and adjust the battery rating (capacity) for the higher discharge rate.

Li-ion: Most Li-ion (and Li-Polymer) batteries can accept a 1.00C Charge and Discharge rate. This is the default Charge and Discharge Rate.

Li-Ph: Li-Ph batteries can accept a 1.00C Charge and Discharge rate. This is the default Charge and Discharge Rate.

Trickle-Charge Rate (NiCd and NiMH only)

The Trickle Charge Rate parameter defines the charge level required to maintain the charge on a NiCd or NiMH battery after service is complete.

Available settings: 1% – 10% of the rated capacity.

The recommended and default rate is 2%. This rate compensates for any self-discharge and maintains temperature. During Trickle Charge, the battery should remain cool and battery temperature should be less than 5°C above ambient temperature. If the battery feels warm, reduce the trickle charge.

Recondition Discharge Rate (NiCd and NiMH only)

The Recondition Discharge Rate parameter refers to a slow, gradual discharge applied during reconditioning after the battery reaches the end-of-discharge voltage. During this process, the crystalline build-up (memory) on the cell plates dissolves and the battery often restores itself.

Available settings: 2% – 20% of discharge rate setting, in increments of 2%.

The recommended and default Recondition and Discharge rate is 12%. This provides the best compromise between speed, effectiveness and safety. The setting is small enough to avoid damage if cell reversal occurs and is large enough to achieve a reasonable, short Recondition Discharge time.

Temperature Sensing

For safety purposes, temperature sensing cannot be disabled for Li-ion batteries. If disabled is selected for other chemistries, temperature is not displayed during service.

Temperature Sensing defines the temperature range within which the battery is serviced (effective only for batteries or adapters equipped with a temperature sensor). The temperature sensor measures the battery temperature either internally or externally. If battery temperature exceeds the maximum threshold, service is suspended until the battery's temperature drops to 5°C below the threshold. If the battery's temperature is below the minimum threshold, service is suspended and the battery is trickle charged until minimum temperature is reached.

The recommended and default setting is 5°C-45°C, which is the ideal battery service temperature range. For NiMH batteries, it is recommended to activate temperature sensing to speed up service. If temperature sensing is disabled, the analyzer automatically applies a rest period to allow NiMH batteries to cool down, which lengthens the service time.

Negative Slope (NiCd and NiMH only)

The Negative Slope measures the voltage drop when the battery reaches full charge. The charge cycle is terminated when the voltage drop reaches the set value.

Available settings: 8mV/cell – 64mV/cell

Recommended and default Negative Slopes:

For 1.2V - 2.4V batteries: 24mV/cell

For 3.6V – 36V batteries: 8mV/cell

Always use the lowest possible negative slope setting. Increasing the negative slope setting delays charge termination causing the battery to heat up at the end of charge. Sometimes, decreasing the negative slope may terminate charge prematurely if the battery has voltage fluctuations due to instability.

End-Of-Discharge

The End-Of-Discharge defines the threshold point at which the discharge cycle is terminated.

Available settings:

NiCd, NiMH: 0.76 – 1.12V/cell

SLA: 1.36 – 1.95V/cell

Li: 2.30 – 3.20V/cell

Li-Ph: 1.90 – 2.35V/cell

Most battery-powered devices are designed to operate at the default settings provided below. However, some devices may have a higher or a lower cut-off value, so these values may have to be adjusted if the battery capacity is being compared to the device used in. Refer to the manufacturer settings for these cases.

NiCd and NiMH: 1.00V/cell.

SLA: 1.75V/cell. This value can vary depending on the Discharge rate used. Refer to the manufacturer specifications.

Li-ion: 3.00V/cell. A good number of Li-ion batteries have 2.50V/cell as the End-Of-Discharge setting. Refer to the manufacturer specifications.

Li-Ph: 2.00V/cell. Refer to the manufacturer specifications.

End of Recondition (NiCd and NiMH only)

The End of Recondition defines the point at which the reconditioning cycle is complete. Recondition is most effective on NiCd batteries. This threshold point leaves the battery fully discharged.

Available settings: Disabled, 0.40 – 0.80 V/cell

The minimum required setting to restore a NiCd battery affected by “memory” is 0.60V/cell. The Cadex analyzer uses 0.40V/cell. SLA and Li-ion batteries cannot be conditioned with a deep discharge.



SMART BATTERIES SHOULD NOT BE RECONDITIONED.

Select DISABLED for the End of Recondition when servicing a smart battery. If the battery's voltage drops below the level required by the processor within the battery, valuable information can be lost. In some cases, this can leave the battery permanently unusable.

Charge Method (NiCd and NiMH only)

This parameter determines the method of charge.

Available settings: DC Charge, No Rev Load, Reverse Load 5% – 12%

The reverse load method intersperses discharge pulses during charge and trickle charge to keep batteries cool and promote the recombination of gases. NO REV LOAD is a charge pulse without the reverse pulse. Best results are achieved using the default Rev. Load 9%. DC Charge is used for batteries that cannot accept a pulse charge (some intrinsically safe batteries fall into this category).

Maximum Standby Voltage (SLA and Li-ion only)

The Maximum Standby Voltage is the level that SLA and Li-ion batteries are maintained when fully charged, after service is complete. A charge current of approximately 0.10C maintains the Maximum Standby Voltage. If the battery voltage exceeds the Maximum Standby Voltage, the current is reduced or eliminated until battery voltage drops to the Maximum Charge Voltage. Refer to the manufacturer's specifications for proper settings. If the battery generates heat during prolonged storage on the analyzer after service has been completed, remove the battery from the analyzer.

Available settings: 2.15 – 2.45V/cell (SLA), 3.90– 4.35V/cell (Li-ion), 3.20 – 3.65V/cell (Li-Ph)

Default Maximum Standby Voltage: SLA: 2.25V/cell; Li-ion: 4.05V/cell; Li-Ph: 3.45V/cell

Maximum Charge Voltage (SLA and Li-ion only)

The Maximum Charge Voltage parameter defines the voltage threshold of SLA and Li-ion batteries that must be maintained until the End of Charge conditions are reached. The charge current drops while the maximum charge voltage is maintained.

Available settings: 2.20 – 2.65V/cell (SLA); 3.90 – 4.35V/cell (Li-ion); 3.40 – 3.85V/cell (Li-Ph)

Default Max. Charge Voltage: SLA: 2.40V/cell; Li-ion: 4.2V/cell; Li-Ph 3.60V/cell

Refer to the manufacturer's specifications for proper settings as these values vary depending on the charge rate used and the ambient temperature.

End of Charge (SLA and Li-ion only)

The End of Charge parameter defines the rate of charge the analyzer uses to determine if the battery is fully charged. When the charge current drops below the End of Charge setting while maintaining the Maximum Charge Voltage, the battery is considered fully charged. Refer to the manufacturer's specification for proper setting as these values vary depending on the charge rate being used. For some batteries, a lower setting is required to ensure adequate charge.

The Charge Optimization setting affects the way the end-of-charge setting is used during a charge (see *Optimizing Charge Time or Capacity*, page 79).

Available settings: 0.01 C – 0.10 C

Default: SLA and Li-ion: 0.05C.

Default: Li-Ph: 0.03C

Default Extended C-code Settings

This section summarizes the extended C-code defaults for each chemistry.

Default Extended C-code for NiCd Batteries

Parameter	Default Setting
Charge	1.00 C
Trickle	5%
Discharge	1.00 C
Recondition	12%
Temperature Sensing	0°C – 45 C
Negative Slope	8mV/cell (16mV/cell for 1.2V and 2.4V batteries)
End-Of-Discharge	1.00V/cell
End of Recognition	0.40V/cell
Charge Method	Reverse Load 9%

Default Extended C-code for NiMH Batteries

Parameter	Default Setting
Charge	1.00 C
Trickle	2%
Discharge	1.00 C
Recondition	12%
Temperature Sensing	0°C – 45 C
Negative Slope	8mV/cell, 16mV/cell for 1.2V and 2.4V batteries
End-Of-Discharge	1.00V/cell
End of Recognition	0.40V/cell
Charge Method	Reverse Load 9%

Default Extended C-code for SLA Batteries

Parameter	Default Setting
Charge	0.30 C
Discharge	0.10 C
Temperature Sensing	0 C – 45 C
Max. Standby Voltage	2.25V/cell
Max. Charge Voltage	2.40V/cell
End of Charge	0.05 C
End-Of-Discharge	1.75V/cell

Default Extended C-code for Li-ion Batteries

Parameter	Default Setting
Charge	1.00 C
Discharge	1.00 C
Temperature Sensing	0 C – 45 C
Max. Standby Voltage	4.05V/cell
Max. Charge Voltage	4.20V/cell
End of Charge	0.05 C
End-Of-Discharge	3.00V/cell

Default Extended C-code for Li-Ph Batteries

Parameter	Default Setting
Charge	1.00 C
Discharge	1.00 C
Temperature Sensing	0 C – 45 C
Max. Standby Voltage	3.45V/cell

Parameter	Default Setting
Max. Charge Voltage	3.60V/cell
End of Charge	0.03 C
End-Of-Discharge	2.00V/cell

Extended C-code Settings for Special Cases

This section lists recommended parameter settings for specific types of batteries, where the recommended settings are different from the default settings.

Intrinsically Safe Batteries

Before servicing intrinsically safe (I/S) batteries, set the following C-code parameters as specified:

Parameter	Setting
Charge	0.10 C*
Discharge	0.10 C*
Charge Method	DC charge
End-Of-Discharge	0.96V/cell

Hawker SLA Batteries

Before servicing Hawker SLA batteries, set the following C-code parameters as specified below (any parameters not listed here should be left at their default settings):

Parameter	Setting
Discharge	0.40 C

* Recommended settings. You can try setting the charge and discharge rates to higher values to speed up servicing; however, if fault codes appear, you must lower the rates.

Parameter	Setting
Max. Standby Voltage	2.35V/cell
Max. Charge Voltage	2.60V/cell
End-Of-Discharge	1.62V/cell

Gell SLA Batteries

Use the SLA default settings for Gell batteries.

Managing C-codes

If the ASK FOR BATTERY C-CODE option is set to YES, the desired C-code must be selected and the appropriate parameters entered before a battery is inserted or before battery processing begins (see *To set the user input required by the Cadex analyzer before battery service begins*, page 77).

Select a C-code

1. From the global display, press the station key.
2. Press ▲ or ▼ to scroll to the C-code to select.
3. Press ENTER.
4. Press ▲ or ▼ to scroll to YES to accept changes and press ENTER.
5. Press ESC twice to return to the global display.

The "*" appears beside the C-code number on the display to indicate that the C-code is active.

Display a C-code

1. From the global display, press the station key.
2. Use the ▲ or ▼ key to scroll to the C-code to display. Basic C-code parameters appear on the same screen.

3. Press ◀ or ▶ to scroll through the extended C-code parameters.
4. After viewing the C-code parameters, press ESC once or twice to return to the global display.

Change Target Capacity or Program

1. From the global display, press the station key.
2. Press EDIT.
3. Press ▲ or ▼ to scroll to the desired program.
4. Press ◀ or ▶ to move to the target capacity field.
5. Press ▲ or ▼ or use the keypad to enter the desired target value.
6. Press ENTER.
7. Press ▲ or ▼ to scroll to YES to accept changes and press ENTER.
8. Press ESC twice to return to the global display.

Create or Edit a C-code

1. From the global display, press the station key.
2. Use the ▲ or ▼ key to scroll to an empty C-code or to the C-code to edit.

An empty C-code contains no battery chemistry (TYPE) and VOLTS and mAh are set to 0.

3. Press EDIT.
4. Select the program to run:
 - a) Press ▲ or ▼ to scroll to the basic program to run.
 - b) Press ▶ to select the program and move to TARGET.

Or

- a) Press ▲ or ▼ to scroll through the basic programs to ADVANCED.
- b) Press ▶ .

- c) Press ▲ or ▼ to scroll to the advanced program to run.
- d) Press ► to select the program and move to TARGET.

At any time from this point, press ENTER to save the changes.

- 5. Press ▲ or ▼ or use the keypad to enter the required target capacity (see *Target Capacity*, page 49).
- 6. Press ► to move to TYPE.
- 7. Press ▲ or ▼ to scroll to the appropriate battery chemistry for the C-code.
- 8. Press ► to move to VOLTS.
- 9. Press ▲ or ▼ or use the keypad to enter the voltage (VOLTS) of the battery to be serviced (see *Battery Voltage (Volts)*, page 49).
- 10. Press ► to move to mAh.
- 11. Press ▲ or ▼ or use the keypad to enter the battery capacity in milliampere hours (mAh) (see *Battery Rating*, page 50).
- 12. Press ENTER.
- 13. To leave the extended C-code parameters at the default settings:
 - a) Press ENTER again.
 - b) Press ▲ or ▼ to scroll to YES to accept changes and press ENTER.

To edit the extended C-code parameters (not usually required):

- a) Press ► .
- b) Edit the extended C-code settings (see *Extended C-code Parameters*, page 51).

Press ► or ◀ to move between C-code settings.

Press ▲ or ▼ or use the keypad to change the settings as required.

- c) Press ENTER.

- d) Press ▲ or ▼ to scroll to YES to accept changes and press ENTER.

14. Press ESC twice to return to the global display.

The message CHANGES ACCEPTED appears on the display.

Add or Edit the C-code Setup Name

1. From the global display, press the station key.
2. Press ▲ or ▼ to scroll to the C-code.
3. Press ALT, and then press EDIT.
4. Press ▲ or ▼ to scroll through upper case letters, lower case letters, punctuation marks, numbers, and a space (which looks like an underscore) to select characters for the setup name.
5. Press ► or ◀ to move the cursor between character positions within the setup name. There are ten positions available.
6. Press ENTER.
7. Press ▲ or ▼ to scroll to YES to accept changes and press ENTER.
8. Press ESC twice to return to the global display.

Reset Extended C-code to the Default settings

1. From the global display, press the station key.
2. Use the ▲ or ▼ key to scroll to the C-code.
3. Press FN and then press 1.
4. Press ▲ or ▼ to scroll to YES to accept changes and press ENTER.
5. Press ESC twice to return to the global display.

(see *Default Extended C-code Settings*, page 57).

Delete a C-code

1. From the global display, press the station key.
2. Use the ▲ or ▼ key to scroll to the C-code.
3. Press FN and then press 0.
4. Press ▲ or ▼ to scroll to YES to accept changes and press ENTER.
5. Press ESC twice to return to the global display.

Copy a C-code (including QuickTest matrix)

1. Ensure both adapters are inserted in the Cadex analyzer. Neither adapter should contain a battery. The source adapter (the adapter with the C-code to be copied) can also be the target adapter (the adapter that will receive the copied C-code.)
2. From the global display, press the station key for the source adapter.
3. Use the ▲ or ▼ key to scroll to the C-code.
4. Press FN, and then press 3.
5. Press the station key for the target adapter. (This can be the same as the source adapter.)
6. Use the ▲ or ▼ key to scroll to the C-code to overwrite.
7. Press ENTER.
8. Press ▲ or ▼ to scroll to YES to accept changes and press ENTER.
9. Press ESC twice to return to the global display.

Copy all C-codes (and matrices) from One Adapter to Another

1. Ensure that both adapters are inserted in the Cadex analyzer. Neither adapter should contain a battery.
2. From the global display, press the station key for the source adapter.
3. Then press FN, and then press 6.
4. Press the station key for the station containing the Target adapter.

5. Press ▲ or ▼ to scroll to YES to accept changes and press ENTER.
6. Press ESC twice to return to the global display.

Chapter 7 System Setup And Options

A number of settings can be customized on the Cadex analyzer. Some of these settings customize the date, time, company name, event log, report or label printing options.

Date and Time

1. From the global display, press MENU.
2. Press ▲ or ▼ to scroll to SYSTEM SETUP and then press ENTER.
3. Press ▲ or ▼ to scroll to DATE/TIME and then press ENTER.
4. Enter the date and time information:
5. Press ► or ◀ to move between fields (year, month, day, hour, minute, and second).
6. Press ▲ or ▼ or use the number pad to enter the correct date and time information for each field.
7. Press ENTER.
8. Press ▲ or ▼ to scroll to YES to accept changes and press ENTER.
9. Press ESC twice to return to the global display.

Note The analyzer is shipped with the date and time set for the Pacific Standard Time (PST) (GMT-8).

Company Name

1. From the global display, press MENU.
2. Press ▲ or ▼ to scroll to OPTION CONTROLS and then press ENTER.
3. Press ▲ or ▼ to scroll to COMPANY NAME and then press ENTER.

4. Enter the company name:
5. Press ▲ or ▼ to scroll through upper-case letters, lower-case letters, punctuation marks, numbers, and a space (which looks like an underscore) to select characters for the program name.
6. Press ► or ◀ to move the cursor between character positions within the program name. There are twenty positions available.
7. Press ENTER.
8. Press ▲ or ▼ to scroll to YES to accept changes and press ENTER.
9. Press ESC twice to return to the global display.

Sound Options

When key press sounds are on, a click noise is made every time a key is pressed on the Cadex analyzer. When various service events occur on the analyzer, such as program completion, an event alert is sounded.

To turn sounds ON or OFF

1. From the global display, press MENU.
2. Press ▲ or ▼ to scroll to OPTION CONTROLS, and then press ENTER.
3. Press ▲ or ▼ to scroll to SOUND CONTROL and then press ENTER.
4. Press ▲ or ▼ to turn the key press sound on (YES) or off (NO).
5. Press ► or ◀ .
6. Press ▲ or ▼ to turn the alert sounds on (YES) or off (NO).
7. Press ENTER.
8. Press ▲ or ▼ to scroll to YES to accept changes and press ENTER.
9. Press ESC twice to return to the global display.

To hear sounds assigned to events

1. From the global display, press MENU.

2. Press ▲ or ▼ to scroll to OPTION CONTROLS and then press ENTER.
3. Press ▲ or ▼ to scroll to SOUND CHECK and then press ENTER.
4. Press ▲ or ▼ to scroll to the event and press ENTER to hear the sound.
5. Repeat step 4 to hear other sounds assigned to the events.
6. Press ESC twice to return to the global display.

Voltage Display

Voltage can display either for the entire battery (terminal voltage) or individual cell voltage (V/Cell). If voltage display is set to V/cell (this is the default), multiply the displayed voltage by the number of cells in the battery to find the voltage for the battery.

On some NiCd and NiMH batteries, manufacturers may rate their batteries based on 1.25V/cell rather than 1.2V/cell. This can also be set on the analyzer (see *Battery Voltage (Volts)*, page 49).

To set the voltage display mode

1. From the global display, press MENU.
2. Press ▲ or ▼ to scroll to OPTION CONTROLS and then press ENTER.
3. Press ▲ or ▼ to scroll to VOLTAGE DISPLAY and then press ENTER.
4. Press ▲ or ▼ to scroll to the required setting:

YES sets the Cadex analyzer to display the voltage of individual cells within the battery (V/Cell).

NO sets the Cadex analyzer to display the terminal voltage for the battery as a whole (Volts).

5. Press ► or ◀ to move to the NiXX field.
6. Press ▲ or ▼ to select 1.20 or 1.25 volts per cell to display for NiCd and NiMH batteries.

7. Press ENTER.
8. Press ▲ or ▼ to scroll to YES to accept changes and press ENTER.
9. Press ESC twice to return to the global display.

Battery Service Counter

The analyzer can be programmed to notify after it has serviced a specified number of batteries. This can be useful, for example, as a reminder to perform routine maintenance tasks such as voltage calibration.

The counter can be restarted from 0 (zero).

To set the battery service counter

1. From the global display, press MENU.
2. Press ▲ or ▼ to scroll to OPTION CONTROLS and then press ENTER.
3. Press ▲ or ▼ to scroll to SET SERVICE COUNTER and then press ENTER.
4. Press ▲ or ▼ or use the number pad to enter the number of batteries to service before the analyzer provides notification.

Set the number to 0 to disable the battery service counter.

5. Press ENTER.
6. Press ▲ or ▼ to scroll to YES to accept changes and press ENTER.
7. Press ESC twice to return to the global display.

To restart the battery service count

1. From the global display, press MENU.
2. Press ▲ or ▼ to scroll to OPTION CONTROLS and then press ENTER.
3. Press ▲ or ▼ to scroll to CLEAR SERVICE COUNTER and then press ENTER.
4. Press ENTER.

5. Press ▲ or ▼ to scroll to YES to accept changes and press ENTER.
6. Press ESC twice to return to the global display.

Note This option is not the same as setting the battery service counter to 0. When the service counter is set to 0 using the SET SERVICE COUNTER option, it is disabled. When this option is used to clear the battery service counter, the service counter is restarting from 0.

To display the number of batteries serviced

This option displays both the total number of batteries serviced and the number of batteries serviced in a session (a session is ended when the service counter is cleared).

1. From the global display, press FN, and then press 5.
2. Press ESC to return to the global display.

Connecting to BatteryShop or a Printer

The Cadex analyzer has a RS232 DB-9-pin female serial port to connect to a label printer or computer. The USB port can only be used to connect to a PC. Other devices may work with the Cadex analyzer but they are not guaranteed to do so. Cadex is not responsible for any issues arising from using any printing devices not sold by Cadex.

Connecting to BatteryShop

To set the analyzer up for BatteryShop, do the following:

- Connect the cable provided with BatteryShop to the USB port or serial port on the analyzer.
- Change the analyzer from STANDALONE mode to BATTERYSHOP mode: Press FN and then press 9 and select Enabled.
- Press ENTER to save the settings.

- These steps are sufficient to set up the analyzer for use with BatteryShop. To use BatteryShop, refer to the BatteryShop users manual on the CDRom.

Connecting Other Devices to the Serial Port

The Cadex analyzer supports the following devices on the serial port:

- Dymo SE250 or SE300 label printer (choose LABEL MAKER device setting) for printing bar-code labels and battery labels. This is the only label printer that is supported. Use the cable that comes with the printer to connect to the analyzer serial port and set the port to LABEL MAKER. Instructions on setting the port are provided below. It is recommended to first power-on the analyzer and then power-on the printer. Powering-on the printer first can lead to erroneous output.
- A PC can be used to manually monitor battery data. Use the cable supplied with BatteryShop™ to connect to the analyzer serial port or make one using the configuration shown in *Typical Serial Cable Pin Configurations*, page 73. A standard serial cable will not work. Set the serial port settings to match the PC port.

The Cadex analyzer offers these settings for the serial port:

Option	Available Settings	Default
Baud Rate	1200, 2400, 4800, 9600, 19200	9600
Handshake	NONE, CTS/RTS, X ON/X OFF	CTS/RTS
Data Bits	7, 8	8
Stop Bits	1, 2	1
Parity	NONE, ODD, EVEN	NONE

To specify and set up the device connected to the Cadex analyzer serial port

1. From the global display, press MENU.
2. Press ▲ or ▼ to scroll to SYSTEM SETUP and then press ENTER.
3. Press ▲ or ▼ to scroll to SERIAL PORT DEVICE and then press ENTER.
4. Press ▲ or ▼ to scroll to the device to connect to the serial port:

- Use BATTERYSHOP to use the unit with Cadex analyzer BatteryShop™ software.
 - Use TERMINAL to connect to a computer to display and analyze service data (see *Logging Data*, page 91)
 - Use LABEL MAKER to connect to a Dymo-CoStar SE300 label printer.
 - Use PRINTER to connect to a serial dot matrix Epson compatible printer. Since serial printers are no longer available, use the USB port or a SP-2 converter (see Appendix D - *Parts and Accessories*, page 154)
 - DISABLED if there are no devices connected to a serial port.
5. Press ENTER.
 6. Press ▲ or ▼ to scroll to YES to accept changes and press ENTER.
 7. Press ▼ to scroll to SERIAL PORT SETTINGS and then press ENTER. Skip this step if connecting to BatteryShop or the Dymo-CoStar SE300 label printer.
 8. Enter the required settings as specified in the device user's manual (see above for available options):
 Press ► or ◀ to move the cursor from option to option.
 Press ▲ or ▼ to scroll through available settings.
 9. Press ENTER.
 10. Press ▲ or ▼ to scroll to YES to accept changes and press ENTER.
 11. Press ESC twice to return to the global display.

Typical Serial Cable Pin Configurations

Note: Do not use these configurations for the Dymo SE300 printer. Use the cable that is supplied with the printer.

DB-9 to DB-25				
DB-9			DB-25	
RD	2	—	2	TD
TD	3	—	3	RD
CTS	8	—	4	RTS
RTS	7	—	5	CTS
SG	5	—	7	SG

Note When connecting to a serial printer, it may also be necessary to jumper pins 6 (DSR), 8 (DCD), and 20 (DTR) together on the printer's DB-25 connector. Other jumpers may also be required. Check the printer manual for specific information.

DB-9 to DB-9				
DB-9			DB-9	
RD	2	—	3	TD
TD	3	—	2	RD
CTS	8	—	7	RTS
RTS	7	—	8	CTS
SG	5	—	5	SG

Note When connecting to a serial printer, it may also be necessary to jumper pins 6 (DSR), 1 (DCD), and 4 (DTR) together on the printer's DB-9 connector. Other jumpers may be also required. Check the printer manual for specific information.

Security

The Cadex analyzer offers three security levels for protection against tampering: Level 0 (off), Level 1 (low), and Level 2 (high). Level 0 is the default. Depending on the security level chosen, a password is required for some features.

A password must have at least three digits.

Security Level Functions

The table below shows functions that require a password at each of the three security levels:

	Functions	Level 0 (Off)	Level 1 (Low)	Level 2 (High)
Services	Start Services	✓	✓	✓
C-code	Edit C-codes	✓	✗	✗

	Functions	Level 0 (Off)	Level 1 (Low)	Level 2 (High)
System Setup	Select C-codes	✓	✓	✗
	Change Time/date	✓	✗	✗
	Select Serial and USB Port devices	✓	✓	✗
Program Settings	Perform Calibration	✓	✓	✓
	Change Program Settings	✓	✓	✓
Option Controls	Change Battery startup options	✓	✓	✗
	Change Company name	✓	✓	✗
	Change Sound control options	✓	✓	✗
Print Utilities	Change Voltage display options	✓	✓	✗
	Select battery service report	✓	✓	✗
	Select battery label	✓	✓	✗
	Select System setup report	✓	✓	✗
	Set Auto-print options	✓	✗	✗
Event Log	Print All Reports	✓	✓	✓
	Clear event log	✓	✗	✗
	Set up events to log	✓	✗	✗

To set the level of security

1. From the global display, press MENU.
2. Press ▲ or ▼ to scroll to SYSTEM SECURITY and then press ENTER.
3. Press ▲ or ▼ to scroll to SET SECURITY and then press ENTER.
4. Press ▲ or ▼ or use the number pad to enter the desired security level (0, 1, or 2).
5. If required, enter the password using the number pad and press ENTER.
6. Press ▲ or ▼ to scroll to YES to accept changes and press ENTER.
7. Press ESC twice to return to the global display.

To change the password

1. From the global display, press MENU.
2. Press ▲ or ▼ to scroll to SYSTEM SECURITY and then press ENTER.
3. Press ▲ or ▼ to scroll to CHANGE PASSWORD and then press ENTER.
4. Enter the old password using the number pad and then press ENTER.
5. Enter the new password, and then press ENTER.
6. Enter the new password again to confirm and then press ENTER.

The message PASSWORD ACCEPTED appears on the display if the password change was successful.

7. Press ESC twice to return to the global display.

If the password is lost, contact Cadex Technical Support at 1 800 565-5228 ext. 315 with your company name and the serial number of the Cadex analyzer.

Program Parameters

There are a number of settings available that affect the way the Cadex analyzer functions in most or all of its programs.

Starting Battery Service

By default, when a battery is inserted into the Cadex analyzer, the analyzer prompts to verify the C-code before service starts. This verification can be turned off so users can run a battery service as soon as a battery is inserted as follows:

- The Cadex analyzer asks for Battery ID number and asks to verify C-code settings.
- The Cadex analyzer asks for Battery ID number only.
- The Cadex analyzer asks to verify C-code settings only (default).
- The Cadex analyzer starts the program using the active C-code without asking to enter the Battery ID or verify the C-code.

To verify C-code or enter Battery ID before battery service begins

1. From the global display, press MENU.
2. Press ▲ or ▼ to scroll to OPTION CONTROLS and then press ENTER.
3. Press ► or ◀ to scroll to ASK FOR BATTERY ID #
4. Press ▲ or ▼ to scroll to the required setting:
 - YES sets the Cadex analyzer to ask for the Battery ID number.
 - NO (default) sets the Cadex analyzer not to ask for Battery ID number.
5. Press ► or ◀ to scroll to ASK FOR BATTERY C-CODE
5. Press ▲ or ▼ to scroll to the required setting:
 - YES sets the Cadex analyzer to ask the user to verify C-code settings.

- NO (default) sets the Cadex analyzer not to ask for the battery C-code.
6. Press ENTER.
 7. Press ▲ or ▼ to scroll to accept changes and press ENTER.
 8. Press ESC twice to return to the global display.

Performing an Automatic OhmTest

Every time the Cadex analyzer runs a charge cycle, it can automatically perform an OhmTest on the battery as well (except when the charge cycle is being performed as part of a custom program). This test can be turned off.

Note Automatic OhmTest cannot be turned on or off using the following programs: QuickTest, Q-Learn, Learn and Life-Cycle. OhmTest is included in these programs and the settings cannot be changed.

To turn Automatic OhmTest on or off

1. From the global display, press MENU.
2. Press ▲ or ▼ to scroll to PROGRAM SETTINGS and then press ENTER.
3. Press ▲ or ▼ to scroll to AUTOMATIC OHMTEST and then press ENTER.
4. Press ▲ or ▼ to scroll to the required setting:
 - YES (default) sets the OhmTest to run automatically before every charge cycle (except during custom programs).
 - NO turns off the automatic OhmTest.
5. Press ENTER.
6. Press ▲ or ▼ to scroll to YES to accept changes and press ENTER.
7. Press ESC twice to return to the global display.

Optimizing Charge Time or Capacity

The end of charge conditions can be modified, (see Appendix B – *Charge Algorithms*, page 148).

To select the charge optimization option

1. From the global display, press MENU.
2. Press ▲ or ▼ to scroll to PROGRAM SETTINGS and then press ENTER.
3. Press ▲ or ▼ to scroll to CHARGE OPTIMIZATION and then press ENTER.
4. Press ► or ◀ to move to between NiCd AND NiMH OPTIMIZATION and SLA AND LI OPTIMIZATION:
5. Press ▲ or ▼ to the required setting (see Appendix B – *Charge Algorithms*, page 148)
 - TIME (default).
 - CAPACITY.
6. Press ENTER.
7. Press ▲ or ▼ to scroll to YES to accept changes and press ENTER.
8. Press ESC twice to return to the global display.

Termination Condition on dT/dt

The Termination Condition on dT/dt parameter sets the temperature a battery can reach before it will terminate or reduce the charge current. If a battery temperature rises more than the dT/dt the charge current is either reduced or charge is completed (see Appendix B – *Charge Algorithms*, page 148).

To select the charge optimization option

1. From the global display, press MENU.
2. Press ▲ or ▼ to scroll to PROGRAM SETTINGS and then press ENTER.
3. Press ▲ or ▼ to scroll to dT/dt TERMINATION and then press ENTER.

4. Press ▲ or ▼ to the required setting (see Appendix B – *Charge Algorithms*, page 148)
 - 2°C RISE PER: 2 MINUTES
 - 2°C RISE PER: 3 MINUTES (default)
 - 2°C RISE PER: 4 MINUTES
5. Press ENTER.
6. Press ▲ or ▼ to scroll to YES to accept changes and press ENTER.
7. Press ESC twice to return to the global display.

Saving Program and Target Capacity Settings

By default, when program and target capacity settings are changes, they are saved in the C-code and stored in the Battery Adapter.

The Cadex analyzer can save these changes to the battery station rather than to the C-code. Settings saved to the station are independent of setting Battery Adapter inserted in the station. Program and target capacity settings programmed into the analyzer station will override the C-codes programmed in the adapter.

Saving program and target capacity is useful if there are several Cadex analyzers and a unit is dedicated to one specific program or target capacity.

To set the method of saving changes to program and target capacity

1. From the global display, press MENU.
2. Press ▲ or ▼ to scroll to OPTION CONTROLS and then press ENTER.
3. Press ▲ or ▼ to scroll to PROGRAM/TARGET CHANGES and then press ENTER.
4. Press ▲ or ▼ to scroll to the required setting:

C-CODE (default) saves any changes made to the program settings or the target capacity to the active C-code.

STATION saves any changes made to the program settings or the target capacity to the battery station. These changes override any settings in the active C-code.

5. Press ENTER.
6. Press ▲ or ▼ to scroll to YES to accept changes and press ENTER.
7. Press ESC twice to return to the global display.

Note To use all of the settings from the active C-code, this option *must* be set to C-CODE. Setting it to C-CODE will erase all settings saved to the stations.

Resuming Service After Power Failure

If there is a power failure, the back-up memory in the analyzer keeps service data for one hour. If the power failure lasts less than an hour, battery service resumes from where it left off. If the power failure lasts longer than one hour, the battery resumes from the beginning. This time can be modified:

To change the Power Failure Resume Hours

1. From the global display, press MENU.
2. Press ▲ or ▼ to scroll to SYSTEM SETUP, press ENTER.
3. Press ▲ or ▼ to scroll to POWER FAILURE RESUME HOURS, press ENTER.
4. Press ▲ or ▼ to scroll to the required setting:
5. Press ENTER. Press ENTER again to save the settings.
6. Press ESC twice to return to the global display.

Short Key Functions

Common functions can be set with the Fn or Alt with number key.

From Edit Display		From Global Display	
Fn-0	Deletes C-code	Fn-5	Views Service Counter
Fn-1	Resets extended C-code to default settings	Fn-7	Views Firmware Version
Fn-2	Erases QuickTest matrix	Fn-8	Calibrates Station
Fn-3	Copies single C-code	Fn-9	Toggles between stand alone and BatteryShop mode
Fn-6	Copies all C-codes from one adapter to another	Stn Key	3 second key press starts Boost
Fn-9	Protects a Matrix from changes. Indicated by 'P' in C-code	Alt-Stn Key	Select 'Restart' to restart service. Select 'Interrupt' – the station will interrupt to remove a battery while it is in service.
Alt-Edit	Enters unique names for C-codes		

Recalibration Counter

The analyzer can be programmed to notify when to calibrate the adapter after it has serviced a specified number of batteries. This can be useful, for example, as a reminder to perform routine maintenance tasks such as adapter calibration.

To set the recalibration counter

1. From the global display, press MENU.
2. Press ▲ or ▼ to scroll to OPTION CONTROLS, press ENTER.
3. Press ▲ or ▼ to scroll to RECALIBRATION COUNTER, press ENTER.
4. Press ▲ or ▼ or use the number pad to enter the number of batteries to service before the analyzer provides notification.

Set the number to 0 to disable the recalibration counter.

5. Press ENTER
6. Press ▲ or ▼ to scroll to YES to accept changes and press ENTER

Press ESC twice to return to the global display.

Chapter 8 Reports and Labels

The Cadex analyzer prints labels and service reports manually or automatically (with Auto-Print). With Auto-Print, a label or service report will print when the battery is removed from the analyzer. With manual printing, the label or report must be printed before the battery is removed from service. The Cadex analyzer supports specific printers (see *Connecting to BatteryShop or a Printer*, page 71). In order to use other types of printers or save service data, Cadex recommends using BatteryShop™.

There are three reports available:

- The **Battery Service Report** includes: the battery ID number; detailed status information; battery parameters (including chemistry, number of cells, rating, and cell voltage); the C-code description; the cycles performed on the battery; charge and discharge rates; any applicable fault codes and final capacities. For a sample battery service report see *Figure 6*, page 85.
- The **System Setup Report**. includes: the time; date; company name; serial port settings; device selected; event log setup; adapter setup and custom program information (the System Setup Report must be printed on a dot-matrix printer).
- The **Adapter Setup Report** report includes: the adapter header information; each C-code and program stored in the adapter and all parameter settings (the Adapter Setup Report must be printed on a dot-matrix printer).

There are also two types of labels:

- **Battery ID label**. This label contains the company name; date of service; test results with any fault codes and the battery ID number (if the battery ID has been programmed into the program parameters). The label is attached to the battery after it is serviced.

- **Bar-code label.** This label contains a bar code representing either the battery ID number or the C-code. For samples of bar code and battery labels, see *Figure 7*, page 86.

BATTERY SERVICE REPORT

Company: CADEX ELECTRONICS
Date: 01/19/2000
Time: 16:47:11

BATTERY STATUS

Battery: STATION 2
Battery ID: 1234567890

Current Cycle: PROCESS COMPLETE
Cycle Capacities: 30% 82% 98%
Battery Resistance: 122m Ω
Cell Voltage: 3.91V/cell
Charge Cycles: 3
Discharge Cycles: 3
Recondition Cycles: 0
Elapsed Time: 0 Days 6 Hours 40 Minutes

BATTERY PARAMETERS

Battery C-Code: 40-02-016:0505-505-3407
Program: Auto
Target Capacity: 80%

Battery Type: 42 - Lithium Ion
Number of Cells: 2 (7.2V)
Battery Rating: 400mAh

Charge Rate: 0.50C (200mA) Max. Charge Voltage: 4.10V/Cell
Discharge Rate: 0.50C (200mA) End Discharge: 4.10V/Cell
End of Charge: 0.10C (40mA) Max. Standby Voltage: 4.05V/Cell
Capacity Offset: 0% Temperature Sensing: 5°C - 45°C

FAULT CODES

FINAL STATUS

Ready

Figure 6: Battery service report

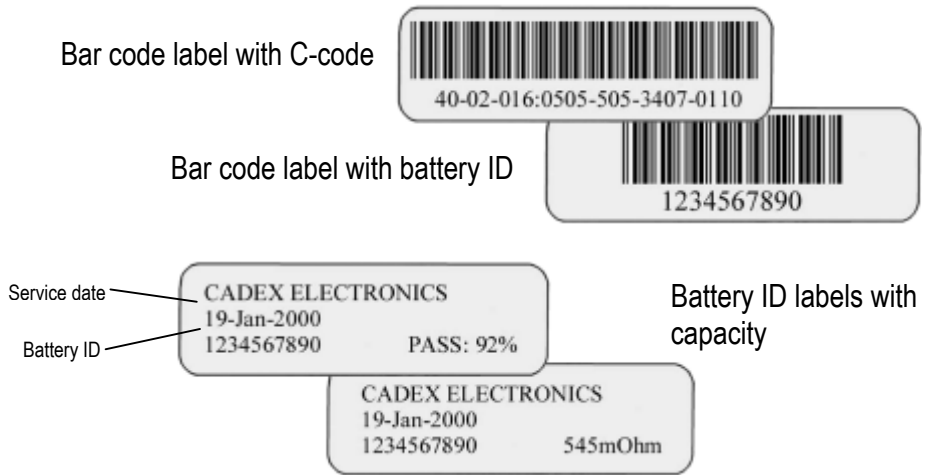

Figure 7: Battery ID and bar code labels

Automatically Print Reports or Labels (Auto-Print)

The Cadex analyzer can print battery service reports or battery labels automatically whenever a battery is removed after servicing.

Automatic Report or Label printing

1. Make sure the printer or a label printer is connected to the analyzer and it is working (see *Connecting to BatteryShop or a Printer*, page 71).
2. From the global display, press MENU.
3. Press ▲ or ▼ to scroll to PRINT UTILITIES and then press ENTER.
4. Press ▲ or ▼ to scroll to AUTO-PRINT and then press ENTER.
5. Press ▲ or ▼ to scroll to LABEL or REPORT, as required. To cancel automatic printing, scroll to NEITHER.
6. Press ENTER.
7. Press ▲ or ▼ to scroll to YES to accept changes and press ENTER.

8. Press ESC twice to return to the global display.

Manually Print Reports and Labels

By default, the analyzer prints battery labels or battery service reports manually. Print the report before removing the battery. Once the battery is removed, service data is deleted from the analyzer and cannot be recovered. If service data needs to be kept, BatteryShop is recommended.

Note Make sure the printer or a label printer is connected to the analyzer and it is working (see *Connecting to BatteryShop or a Printer*, page 71).

Tip Reports and labels can be printed through the menu under PRINT UTILITIES.

Print a battery service report

1. Perform the required service on the battery. Do not remove the battery from the adapter.
2. Press PRINT.
3. Press the station key of the station that contains the battery.
4. Press ▲ or ▼ to scroll to BATTERY SERVICE REPORT.
5. Press ENTER.

Print an adapter setup report

1. Press PRINT.
2. Press the station key of the station that contains the battery.
3. Press ▲ or ▼ to scroll to ADAPTER SETUP REPORT.
4. Press ENTER.

Print a system setup report

1. From the global display, press MENU.
2. Press ▲ or ▼ to scroll to PRINT UTILITIES and press ENTER.

3. Press ▲ or ▼ to scroll to SYSTEM SETUP REPORT and press ENTER.

Print a battery label

1. Perform the required service on the battery. Do not remove the battery from the adapter.
2. Press PRINT.
3. Press the station key of the station that contains the battery.
4. Press ▲ or ▼ to scroll to BATTERY LABEL.
5. Press ENTER.

Print a label with a battery ID bar code

1. Perform the required service on the battery. Do not remove the battery from the adapter.
2. Press PRINT.
3. Press the station key of the station that contains the battery.
4. Press ▲ or ▼ to scroll to ID # BAR CODE LABEL.
5. Press ENTER.

Print a label with a bar code for the active C-code

1. Press PRINT.
2. Press the station key of the station that contains the battery.
3. Press ▲ or ▼ to scroll to BAR CODE FOR ACTIVE C-CODE.
4. Press ENTER.

Logging Events

The event log stores data concerning the fifty most recent eligible events. This allows tracking of general battery service trends as well as identification of potential problems.

DATE	TIME	STN	CODE	DESCRIPTION
01/18/2000	14:07	0	200	POWER ON
01/18/2000	14:07	0-1	201	ADAPTER INSERTED
01/18/2000	14:07	0-2	201	ADAPTER INSERTED
01/18/2000	18:57	0-1	115	TARGET CAPACITY NOT MET
01/18/2000	19:00	0-1	26	BATTERY REMOVED
01/19/2000	10:25	0-2	18	PROCESS SUSPENDED
01/19/2000	10:25	0-2	188	SUSPENDED PROCESS ABORTED
01/19/2000	10:25	0-2	17	BATTERY REMOVED

Figure 8: Sample event log

Setting up the Event Log

There are several types of events that the Cadex analyzer can log.

Event	Description
Errors	Problems that stop the service.
Warnings	Problems that do not stop the service, but may affect battery performance.
System Events	Events recorded by the system.
Battery Events	Completed actions or programs in a battery service cycle.
Battery Cycles	Detailed events in a battery service cycle.
Echo to Printer	Instruction to send events to the printer.

To set up the types of events to be logged

1. From the global display, press MENU.
2. Press ▲ or ▼ to scroll to EVENT LOG and then press ENTER.
3. Press ▲ or ▼ to scroll to EVENTS TO LOG and then press ENTER.
4. For each event type:

Press ▲ or ▼ to scroll to YES to include it in the event log or NO not to include it.

Press ► to move to the next event type.

1. Press ENTER when to have all events logged.
2. Press ▲ or ▼ to scroll to YES to accept changes and press ENTER.
3. Press ESC twice to return to the global display.

Using the Event Log

To print the event log

1. Make sure the printer or a label printer is connected to the analyzer and it is working (see *Connecting to BatteryShop or a Printer*, page 71).
2. From the global display, press MENU.
3. Press ▲ or ▼ to scroll to EVENT LOG and then press ENTER.
4. Press ▲ or ▼ to scroll to PRINT EVENT LOG and then press ENTER.

To display the event log on the LCD display

Fifty of most recently logged events can be displayed on the analyzer.

1. From the global display, press MENU.
2. Press ▲ or ▼ to scroll to EVENT LOG and then press ENTER.
3. Press ▲ or ▼ to scroll to VIEW EVENT LOG and then press ENTER.
4. Press ▲ or ▼ to scroll through the events in the log.

5. Press ESC when complete.
6. Press ESC twice more to return to the global display.

To remove all logged events from the event log

1. From the global display, press MENU.
2. Press ▲ or ▼ to scroll to EVENT LOG, and then press ENTER.
3. Press ▲ or ▼ to scroll to CLEAR EVENT LOG and then press ENTER.
4. Press ▲ or ▼ to scroll to YES to accept changes and then press ENTER.
5. Press ESC twice to return to the global display.

Logging Data

When the Cadex analyzer is connected to a computer, data logs can be recorded on a computer as text strings. Each text string appears on a line by itself. For an example of data logged with Microsoft's HyperTerminal program (see *Figure 9*, page 92).

Note When using BatteryShop, the software's Data Monitor function is similar to the Data Log.

Two types of text strings are created when logging data. The first is the "event string", which is generated whenever a specific event occurs. Some examples of specific events that would generate this type of data string are the start or end of a specific phase in a program; a battery or adapter insertion or removal and errors and warnings. The second, and most common event string is the "processing string", which updates battery data once a minute and indicates normal battery processing.

Text strings have seven or eight fields, which are separated by commas. The first six fields in both types of text strings are identical and represent these data elements:

- **Analyzer number.** This number is always "0".

- **Station number.** This is the number of the battery station that reported the data string.
- **Battery ID.** This field displays the battery ID, if it was entered in the Cadex analyzer. The Battery ID field always has 10 characters but some or all of them may be blank spaces.
- **Date.** This is the date the data string was created, in the format mm/dd/yyyy. This string reflects the Cadex analyzer date settings, not those of the computer.
- **Time.** This is the time the data string was created, using the 24-hour clock and in the format hhmmss. This string reflects the Cadex analyzer time settings, not those of the computer.
- **Event Code.** This number indicates which event has been reported. Processing strings always display event code 250, which indicates normal processing. Event strings can display any event code other than 250. For a list and explanation of event codes, see *Messages and Warnings*, page 123.

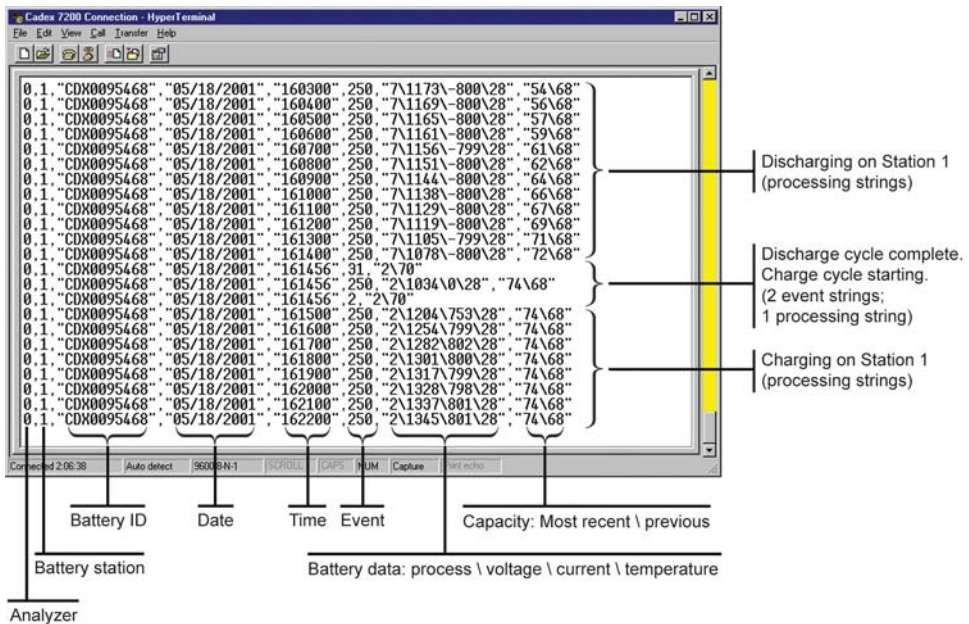

Figure 9: Sample data logged to HyperTerminal.

The content of the final part of the strings depends on the string type. Processing strings (Code 250) contain two additional fields:

- **Battery data.** This field displays four different data elements, in this order:

Process or status. This number represents the process or status of the current program as listed in *Appendix A, Messages and Warnings* (see *By Code*).

Voltage. This is the terminal voltage of the battery in mV.

Current. This is the charge or discharge current being applied to the battery in mA. If the current number is positive, the battery is being charged; if it is negative, the battery is being discharged.

Battery temperature. This is battery temperature in degrees Celsius. If temperature sensing is disabled in the C-code, this value is always 0.

Back-slash characters separate the four elements.

- **Battery capacity.** In most cases, this field displays the current (or most recent) battery capacity and the previous battery capacity, both as percentages of the nominal battery capacity in the C-code. A back-slash character separates the two capacities. Current battery capacity is updated (increased) during discharge cycles.

Note If running QuickTest, this field displays the battery SoH (State-of-health) as a percentage, followed by the ASCII value of the confidence grade for the matrix (A = 65, B = 66, C = 67).

The bottom text string in *Figure 9* is a processing string. It indicates that the battery in station 1 (ID CDX0095468) is processing normally (event 250), charging (process 2) with a terminal voltage of 1345mV, a charge current of 801mA, and a battery temperature of 28°C. The most recent battery capacity achieved was 74%; the previous capacity was 68%.

Event strings contain one or two fields in addition to the first six:

- **Program and target capacity.** This field displays a one- or two-digit number representing the current program and the target capacity from the C-code. A back-slash character separates the two elements.

Program codes are:

0	= Auto	9	= Self-Discharge
1	= Charge	10	= LifeCycle
2	= Prime	11	= Discharge Only
3	= Custom1	12	= Extended Prime
4	= Custom2	13	= Boost
5	= Custom3	14	= QuickTest
6	= Custom4	15	= Q-Learn
7	= OhmTest	16	= Learn
8	= Runtime	17	= QuickSort

- **Battery data.** In certain cases, event strings also contain a battery data field. For example, when an automatic OhmTest is run as part of a program, the event string generated includes the OhmTest results in mΩ.

Sample text strings

Here are some sample data logging text strings followed by explanations.

```
0,2,"          ", "01/24/2001", "085120", 201, "0\80"
```

- a) A Battery Adapter was inserted (Code 201) in station 2 on January 24, 2001 at 8:51 a.m. The current C-code specifies the Auto program with a target capacity of 80% (0\80 in the final field). Battery ID is not yet available.

```
0,2,"          ", "01/24/2001", "085121", 20, "0\80"
```

- b) A battery was inserted in the adapter (Code 20).

0,2,"CDX01", "01/24/2001", "085140", 11, "0\80"

- c) Processing of the current program began (Code 11). The battery ID is CDX01.

0,2,"CDX01", "01/24/2001", "085140", 250, "2\1416\398\21", ""

- d) Normal processing (Code 250) of battery CDX01. The battery is charging (process = 2), terminal voltage is 1416mV, charge current is 398mA, and battery temperature is 21°C. Battery capacity has not yet been determined.

0,2,"CDX01", "01/24/2001", "085456", 27, "0\80", 341

- e) An OhmTest was performed (Code 27). Resistance is measured at 341mΩ.

0,2,"CDX01", "01/24/2001", "100200", 250, "7\1419\401\35", "85\37"

- f) Normal processing (Code 250). The battery is discharging (process = 7), terminal voltage is 1419 mV, discharge current is 401mA, and battery temperature is 35°C. Current battery capacity is 85%; previous capacity was 37%.

0,2,"CDX01", "01/25/2001", "090500", 250, "5\1694\7\28", "89\87"

- g) Normal processing (Code 250). The battery is ready (process = 5), terminal voltage is 1694 mV, charge current is 7mA (trickle charge), and battery temperature is 28°C. Final battery capacity achieved is 89%; previous capacity was 87%.

0,2,"CDX090", "04/11/2001", "151600", 250, "35\3943\0\23", "76\67"

- h) Normal processing (Code 250) of battery ID CDX090. A QuickTest has been completed (status code 35). Terminal voltage is 3943mV, no current is being applied, and battery temperature is 23° C. The battery SoH is 76% with a confidence grade of 67, the ASCII code for "C". ("A" is 65, and "B" is 66).

Setting up the Data Log

To log data to a computer, connect the Cadex analyzer to the serial port of a computer (see *Connecting to BatteryShop or a Printer*, page 71), set the Cadex analyzer to log data, and set up a program to read the data from the serial port. The procedure outlined here assumes Microsoft's HyperTerminal communications program is used, which comes with most versions of Microsoft Windows; however, any compatible communications program that can read data through the computer serial port can be used.

To set the Cadex analyzer to log data to a computer

1. From the global display, press MENU.
2. Press ▲ or ▼ to scroll to SYSTEM SETUP and then press ENTER.
3. Press ▲ or ▼ to scroll to SERIAL PORT DEVICE and then press ENTER.
4. Press ▲ or ▼ to scroll to TERMINAL and then press ENTER.
5. Press ▲ or ▼ to scroll to YES to accept changes and press ENTER.
6. Press ▼ to scroll to SERIAL PORT SETTINGS and then press ENTER.
7. Pressing ► or ◀ to move the cursor between options and ▲ or ▼ to scroll through available settings, enter these serial port settings:
 - baud rate: 9600
 - handshake: none
 - data bits: 8
 - stop bits: 1
 - parity: none
8. Press ENTER.
9. Press ▲ or ▼ to scroll to YES to accept changes and press ENTER.
10. Press ESC twice to return to the global display.

To set HyperTerminal to read Cadex analyzer data

1. Click **Start** on the Windows Task Bar, point to **Programs**, then point to **Accessories**, and then click **HyperTerminal**.
2. Double-click the **HyperTrm** or **HyperTrm.exe** icon.
3. Type a name for the data log connection, such as **Cadex analyzer connection**, and then click **OK**.
4. In the dialog box that appears, enter these settings:

Connect using. From the list, select **Direct to Comx**, where x is the number of the serial port to which the analyzer is connected.

- Bits per second: 9600
- Data Bits: 8
- Parity: None
- Stop Bits: 1
- Flow Control: None

5. Click **OK**.

The HyperTerminal screen appears. The bottom left-hand corner of the screen should display the message "Connected h:mm:ss".

6. Check that HyperTerminal is communicating with the Cadex analyzer by inserting an adapter in any station on the analyzer. A text string similar to this one should appear on-screen:

```
0,2,"          ", "01/25/2001", "095126",201,"0\80"
```

If nothing appears on-screen, check the HyperTerminal properties:

Click **File**, and then click **Properties**.

Verify that the serial communication port number is correct.

Click **Configure**, and verify that the serial port settings match the Cadex analyzer serial port settings.

If the Properties settings are correct, check the serial cable and connections, and verify the serial port settings on the computer and battery analyzer.

Using the Data Log

Once the connection file has been set up, use that file to open HyperTerminal and log Cadex analyzer data. Save Cadex analyzer data logs by capturing them as text files, which can be imported into a spreadsheet program such as Microsoft Excel for graphing and analysis.

To log and save data to a text file

1. Click **Start** on the Windows Task Bar, point to **Programs**, then point to **Accessories**, and then click **HyperTerminal**.
2. Double-click **Cadex analyzer Connection** (or the name given to the connection when it was first set up).

HyperTerminal opens and starts displaying data sent from the Cadex analyzer.

3. Click **Transfer**, and then click **Capture Text**.
4. Type a name for the data log text file, giving it a **.txt** extension.
To change the file location, click **Browse** and specify a different folder.
5. Click **Start**.

Data starts to be saved from the highlighted point on-screen.

6. When all the data has been captured, click **Transfer**, then point to **Capture Text**, and then click **Stop**.

The text file is created and it can now be imported into a spreadsheet program for further analysis.

To open the data log in Microsoft Excel

1. Start Microsoft Excel.

2. Click **File**, and then click **Open**.
3. In the dialog box that appears, navigate to the folder with the saved data log text file.
4. In **Files of Type**, select **Text Files (*.prn; *.txt; *.csv)**.
5. Click the name of the text file to open in Microsoft Excel.
6. Click **Open**.

Use Microsoft Excel functions to analyze, graph, or create a report of the data.

Note The data is not limited to spreadsheet programs. Depending on what to do with the data, the file can be opened in any software program that recognizes comma-separated-values files. This may include word processing programs and database programs, among others.

Chapter 10 Custom Programs



These features are recommended for advanced users only.

Creating a custom program requires a good understanding of rechargeable batteries and the analyzer. Applying routines that conflict with the battery manufacturer's specifications or recommendations can damage a battery.

If custom programs are modified regularly, use Cadex BatteryShop™. The graphical user interface of Cadex BatteryShop™ allows easy programming and monitoring of battery performance. See Cadex's BatteryShop™ online Help for detailed instructions.

Custom programs can run virtually any sequence of service cycles. They are stored in the analyzer to be globally used by any adapter.

A custom program consists of phases 1 through 5, followed by phase DONE.

- Each of the first five phases consists of two cycles, a test, and the TRUE and FALSE statements, as shown in the flow chart in Figure 10.

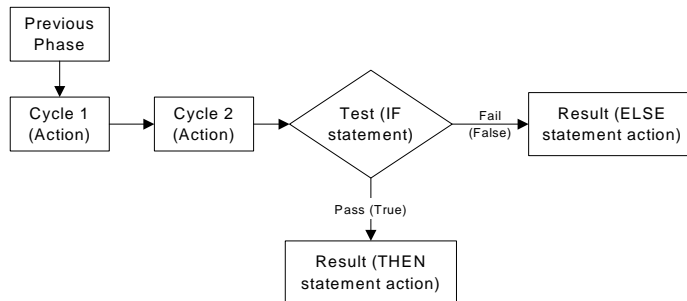

Figure 10: Custom program process, phases 1 through 5

- Phase Done consists of Cycle 1 only and does not proceed to any other cycle.

The analyzer goes through the first phase, then follows the paths prescribed by the IF, THEN, and ELSE statements in the test cycle of each phase.

Cycle 1 and Cycle 2

There are seven different actions that can be performed as Cycle 1 or Cycle 2 of phases 1 through 5.

Action	Description
Skip Cycle	Skips the cycle and goes to the next cycle or the TEST statement.
Discharge Time (for 000:00:00 at 100%)	Discharges the battery for the specified time period (hhh:mm:ss)* at the discharge rate set in the extended C-code. A setting of 50% gives a discharge current that is 50% of the C-code discharge rate (see <i>Discharge Rate</i> , page 52).
Charge Time (for 00:00:00 at 100%)	Charges the battery for the specified time period (in hhh:mm:ss format)* at the charge rate set in the extended C-code.
Recondition Time (for 000:00:00)	Reconditions (deep discharges) the battery for the specified time period (hhh:mm:ss)* at the recondition discharge rate set in the extended C-code. This cycle is skipped for SLA, Li-Ion and Li-Ph because these chemistries cannot be reconditioned. This cycle can be applied only after a discharge cycle.
Trickle-Charge Time (rest for 000:00:00)	Charges NiCd and NiMH batteries for the specified time period (hhh:mm:ss)* at the trickle-charge rate set in the extended C-code. This cycle is skipped for SLA, Li-Ion and Li-Ph.

* If the default time period of 000:00:00 is used, the analyzer services the battery according to end-of-charge, end-of-discharge or end-of-recondition settings in the extended C-code. The maximum allowable is 200:59:59.

Action	Description
Rest Time (rest for 000:00:00)	Applies no current for the specified time period (hhh:mm:ss)*. The time must be specified or the cycle is skipped.
OhmTest	Performs the OhmTest on the battery.

Test

The test cycle has three parts:

- The IF statement, which describes a condition that must be either true or false for the battery being tested.
- The THEN statement, which describes the action to be taken if the battery passes the test (the condition is true).
- The ELSE statement, which describes the action to be taken if the battery fails the test (the condition is false).

IF Statements

Choose from ten different test conditions, or IF statements, when setting tests for phases 1 through 5.

IF Statement	Description
Skip Test	Selects the TRUE statement. The FALSE statement is ignored.
IF Target Capacity Met	Selects the TRUE statement if the capacity during the last discharge cycle meets the target capacity; otherwise, selects the FALSE statement.
IF Target Capacity Not Met	Selects the TRUE statement if the capacity during the last discharge is below the target capacity; otherwise, selects the FALSE statement.

IF Statement	Description
IF < 5% Capacity Increase	Selects the TRUE statement if the improvement in capacity during the last two discharge cycles is less than 5% (for example, the last one is 88% and the one before is 85%); otherwise (for example, if the last one is 90% and the one before is 80%), selects the FALSE statement.
IF > 5% Capacity Increase	Selects the TRUE statement if the improvement in capacity during the last two discharge cycles is more than 5% (for example, the last one is 90% and the one before is 80%); otherwise (for example, 88% and 85%) selects the FALSE statement.
IF Total Capacity < 5%	Selects the TRUE statement if the capacity during the last discharge cycle is less than 5%; otherwise, selects the FALSE statement.
IF Total Capacity > 5%	Selects the TRUE statement if the capacity during the last discharge cycle is greater than 5%; otherwise, selects the FALSE statement.
IF User Defined Timeout	Selects the TRUE statement if the time period set in Cycle 1 or Cycle 2 expires before the battery is fully charged, discharged or reconditioned; otherwise, selects the FALSE statement. For Trickle Charge and Rest, the program selects the TRUE statement only.
IF Loop Count < Max	Selects the TRUE statement if the number of cycles (the loop count) is less than the value set in THEN REPEAT x TIMES of the TRUE statement or ELSE REPEAT x TIMES in the FALSE statement; otherwise, selects the FALSE statement.
IF Loop Count > Max	Selects the TRUE statement if the number of cycles (the loop count) is more than the value set in THEN REPEAT x TIMES of the TRUE statement or ELSE REPEAT x TIMES in the FALSE statement; otherwise, selects the FALSE statement.

THEN and ELSE Statements

There are ten possible responses to the results of the IF statement. Each of these responses is available as a THEN statement (for when a battery meets the condition, or passes) or as an ELSE statement (for when a battery does not meet the condition, or fails).

THEN/ELSE Statement	Description
Starts the next phase.	Starts the next phase.
Go to Phase 1	Starts Phase 1.
Go to Phase 2	Starts Phase 2.
Go to Phase 3	Starts Phase 3.
Go to Phase 4	Starts Phase 4.
Go to Phase 5	Starts Phase 5.
Go to Done	Starts Phase Done.
REPEAT 0 times	Repeats actions in the current phase the number of times specified. Available settings: 1 to 8 FOREVER. The program continues forever. See the “IF Loop Count<Max” and “IF Loop Count>Max” statements, above.
REST for 000:00:00	Applies no current for the specified time period (in hhh:mm:ss format). The RESTING message (code 19) is displayed with time counting down. After resting, the program goes to the next phase.
FAIL	Fails the battery. The battery is electrically disconnected, the FAIL light comes on, and the WARNING message (code 16) appears.

Phase Done

Perform one of three different actions in the final phase of the custom program.

Action	Description
--------	-------------

Ready—No Charge	Ends the program. The green READY light is on, and no trickle charge is applied.
Ready—Trickle Charge	Trickle-charge the battery using the trickle-charge rate in the extended C-code. Includes the standby maintenance cycle, which performs a discharge/charge every 30 days (180 days for SLA).
Trickle Charge	Trickle-charge the battery using the trickle-charge rate in the extended C-code.

Creating and Editing Custom Programs

To create or edit a custom program

1. From the global display, press MENU.
2. Press ▲ or ▼ to scroll to PROGRAM SETTINGS and then press ENTER.
3. Press ▲ or ▼ to scroll to CUSTOM PROGRAMS and then press ENTER.
4. Press ▲ or ▼ to scroll to the program to create or edit, for example, CUSTOM 1.
5. Press EDIT. The cursor appears on Phase 1.
6. Press ► to move the cursor to the Cycle 1 field.
7. Program the action to be completed during this cycle:

Press ▲ or ▼ to select the action.

Press ►.

If necessary, use the direction keys or the number pad to enter any additional settings required for the cycle and then press ►.

1. Repeat step 7 for Cycle 2 of the phase.
2. Program the test for the phase:

Press ▲ or ▼ to select the IF statement, the test to be performed. (see *Test*, page 102).

Press ►.

Press ▲ or ▼ to select the THEN, or TRUE, statement (the action to be performed if the battery passes the test). Available THEN and ELSE statements are described on page 104.

Press ▶ .

Press ▲ or ▼ to select the ELSE, or FALSE, statement (the action to be performed if the battery fails the test).

Press ▶ .

1. Press ▲ to move to the next phase.
2. Repeat steps 6 – 1 for phases 2 – 5.

Once Phases 1 through 5 have been programmed, the cursor appears on Phase Done.

3. Program the action for Phase Done:

Press ▶ to move to Cycle 1.

Press ▲ or ▼ to select the action to be performed. (There is only one cycle for Phase Done.)

1. After all the settings have been entered, press ENTER.
2. Enter a name for the program, if desired:

Press ▲ or ▼ to scroll through upper case letters, lower case letters, punctuation marks, numbers, and a space (which looks like an underscore) to select characters for the program name.

Press ▶ or ◀ to move the cursor between character positions within the program name. There are seven positions available.

3. Press ENTER.
4. Press ▲ or ▼ to scroll to YES to accept changes and press ENTER.
5. Press ESC twice to return to the global display.

Sample Custom Program

NiCd or NiMH batteries that do not meet the target capacity should always be reconditioned. If the battery does not meet the target capacity after reconditioning, the program fails the battery.

Phase	Action
Phase 1	Charge the battery.
Phase 2	Discharge to find the battery capacity. If the capacity meets the target capacity, complete the program (Phase Done). If the target capacity is not met, apply the recondition cycle (Phase 3).
Phase 3	Recondition and charge the battery.
Phase 4	Discharge to find capacity after the recondition cycle. If the capacity meets the target capacity, charge the battery (Phase 5). If the target capacity is not met, fail the battery.
Phase 5	Fully charge the battery.
Phase Done	Complete the program with a trickle charge to maintain capacity.

The flowchart in Figure 11 on the next page demonstrates how this program works.

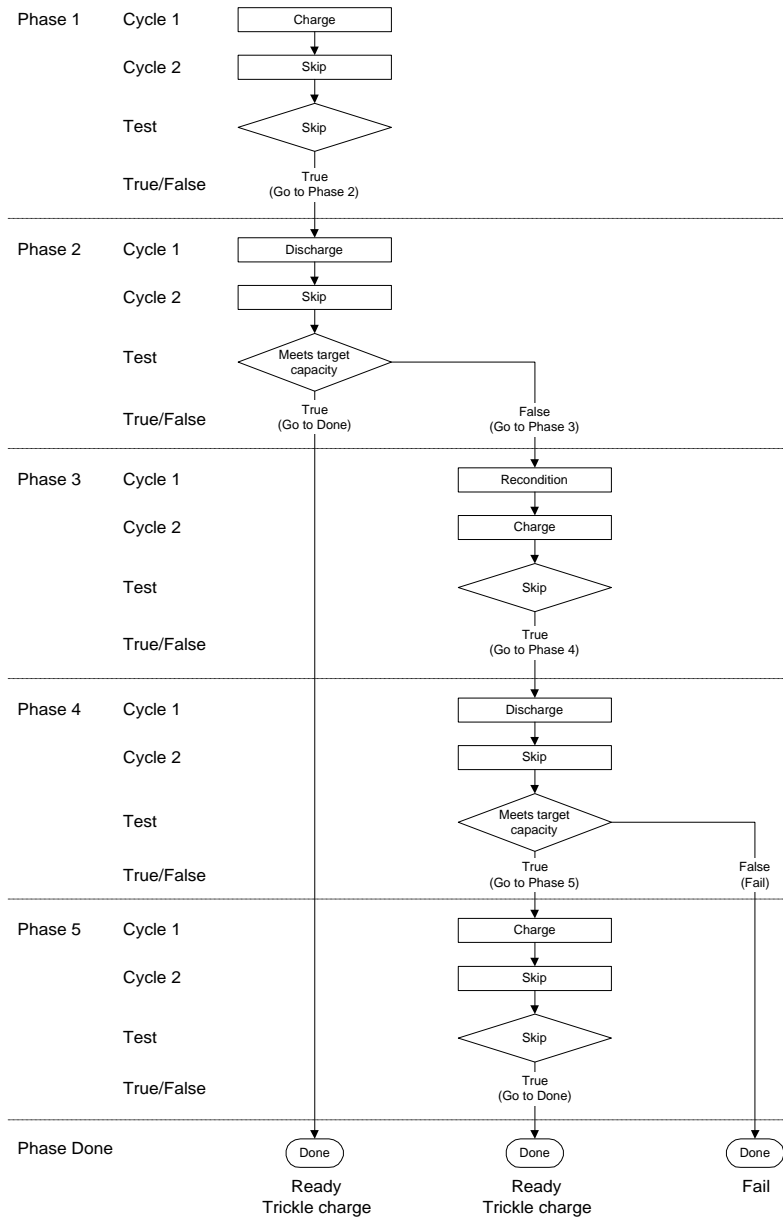

Figure 11: Flow chart for sample custom program

Chapter 11 Services and Upgrades



CAUTION

There are no internal user-serviceable parts in the Cadex analyzer. Unauthorized disassembly and/or repair of the analyzer by other than an authorized Cadex Service Center will void the warranty.

Replacing the Primary (Input) Fuse

If the analyzer does not power up, first check that the power cord is properly inserted and there is power available. If the analyzer does not power up, then primary (input) fuse may need to be replaced (see Appendix D - *Parts and Accessories*, page 154).

To replace the primary fuse

1. Remove all batteries and adapters, turn off the analyzer and unplug the power cord. Wait one minute before continuing.
2. Locate the fuse holder below the power cord socket.
3. Open the fuse cover by turning it counterclockwise with a small coin or screwdriver.



Turn the fuse cover counterclockwise with a small coin or screwdriver.

Figure 12: Replacing the fuse

4. Remove and examine the fuse carefully.

If the filament inside the glass tube is broken, replace the fuse. Be aware that the filament can sometimes appear intact even when it is broken.

5. Close the fuse cover by pushing and turning it clockwise with a small coin or screwdriver until it locks in place.
6. Insert the power cord and turn on the analyzer.

Upgrading the Firmware

From time to time, Cadex offers firmware upgrades for the analyzer. These can usually be downloaded to from www.cadex.com and then copied to the analyzer using the Cadex Firmware Utility software, available from Cadex Electronics Inc. (the Firmware Utility software comes with BatteryShop).

The current version of the firmware is always displayed in the lower left-hand corner of the analyzer startup screen, followed by the current version of the Cadex Firmware Utility software, as shown here:

```
C7400-C (C)2006 CADEX ELECTRONICS INC.  
V1.00/1.00 ** DIAGNOSTICS PASSED **
```

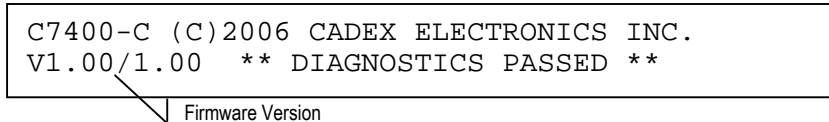

To verify firmware version (display start-up screen)

1. From the global display, press FN and then press 7.
2. Press ESC to return to the global display.

Resetting the System

To reset parameters to the factory default and restart the analyzer

1. Remove all batteries and adapters.
2. Power-off the analyzer.
3. Hold down the MENU key.

4. Power on the analyzer and release the MENU key
5. Allow the analyzer to complete bootup. The analyzer will enter a Test Mode during this sequence.
6. Power off the analyzer and then power it on as normal.

The parameters that are reset to their default values include:

- OhmTest, Runtime, Self-Discharge, Life Cycle and custom programs.
- Battery startup settings.
- Key sound and alert sound.
- USB port device.
- Voltage display.
- Service counter (number of batteries serviced).
- The setting for the serial port device changes to BATTERYSHOP.

Cleaning the Analyzer



Caution! Before cleaning, turn off the power and unplug the AC power cord.

Clean the analyzer only with a damp cloth moistened with mild soap and water and allow to thoroughly dry. Do not allow any liquids to enter the analyzer case under any circumstances.

Chapter 12 System Calibration

There are two kinds of calibration that should be performed on the Cadex analyzer on a regular basis: voltage calibration and adapter calibration.

Voltage Calibration

Voltage calibration should be performed yearly and a calibration kit is required.

The C7000-C Series of Battery Analyzers uses Calibration Kit P/N 92-770-0212 (See Appendix D - *Parts and Accessories*, page 154).

To calibrate the voltage

1. Remove all Battery Adapters.
2. From the global display, press MENU.
3. Press ▲ or ▼ to scroll to SYSTEM SETUP and then press ENTER.
4. Press ▲ or ▼ to scroll to CALIBRATE VOLTAGE and then press ENTER.
5. Firmly insert the four voltage calibration adapters, one into each station. (If calibrating a C7200, only two voltage calibration adapters are necessary)
6. Wait for the prompt, and then remove the calibration adapters.
7. Press MENU to return to the global display.
8. Press FN, and then press 7. The “#” sign appears in the upper right corner of the startup screen, indicating successful completion of voltage calibration.

Servicing the Voltage Calibration Adapters

Return the voltage calibration adapters to the factory every two years for authorized calibration. Contact Cadex for a Return Authorization number.

Adapter Calibration

Battery Adapters should be calibrated once a year or whenever they are moved from one station to another. Station calibration corrects variations in tolerances due to aging of the adaptor components and also compensates for loss of voltage from cables and electrical contacts.

Failure to calibrate Battery Adapters can cause inaccurate capacity readings, especially on low voltage batteries or single cells operating at high charge or discharge currents. OhmTest, QuickSort and QuickTest results can also be affected, in some cases dramatically.

To calibrate an adapter

1. Make sure that there is no battery inserted into the adapter.
2. From the global display, press FN and then press 8.

Or

3. From the global display, press MENU.
4. Press ▲ or ▼ to scroll to SYSTEM SETUP and then press ENTER.
5. Press ▲ or ▼ to scroll to CALIBRATE ADAPTER and then press ENTER.
6. Press the station key that has the adapter.

Use a short length of heavy gauge wire (AWG 10) or a copper plate to short the positive and negative terminals on the Battery Adapter together. If calibrating a Smart Cable Adapter, clip the leads together.



Do NOT short the temperature sensor on the adapter.

Do NOT short the contacts on a BATTERY.

7. Press ENTER to start calibrating. Calibration takes about 20 seconds so remember to maintain constant pressure on the adapter's terminals until the test is fully completed.
8. Remove the adapter when prompted.

Adapter Calibration Values

Adapters are calibrated at the factory and the calibration value is permanently stored in adapter memory. After calibration, the new calibration value and factory calibration value are compared.

- If the difference between the calibration values is less than 50mΩ, the new value is displayed on the screen and replaces the factory calibration value.
- If the difference is more than 50mΩ, the calibration value and the original factory calibration value is displayed; select Yes or No to accept or discard the new value.
- If the new calibration is over 400mΩ, the new value is rejected.

Acceptable Calibration Values for New Adapters

General calibration values are provided below to help gauge whether a calibration has been performed properly. If a brand new adapter is calibrated using appropriate tools and the displayed resistance is greater than that shown below, repeat the calibration.

To check the analyzer version, press the keys Fn-7. If the adapter is consistently displaying larger resistance values than in the list, please contact technical support (page 121).

Table 1 Typical Calibration Resistance Values

Contact Type	C7400 Version 6.x	C7400-C Version 1.x
Spring loaded contact adapter	C7200, C7400 and C7400ER < 250mΩ	C7400-C < 100mΩ
Smart Cable (07-110-0115)	C7400 < 270mΩ C7400ER < 330mΩ	C7400-C < 150mΩ
FlexArm (07-110-0180) and RigidArm (07-110-0190)	C7200, C7400 and C7400E < 380mΩ	C7400-C < 150mΩ

These ranges are only for new adapters shorted with gold plating. Older adapters or those adapters shorted with different materials may have higher values.

Chapter 13 Solving Problems and Getting Help

Troubleshooting

The common problems and solutions listed below will answer most of questions. The detailed alphabetical list of display messages in Appendix A - *Messages and Warnings* on page 123 can help to sort out problems not listed here.

<u>Problem</u>	<u>Possible Reasons or Solutions</u>
Analyzer does not power up.	Make sure that the power cord is firmly inserted in the back connector. Check the power supply Check the input fuse, (see <i>Replacing the Primary (Input) Fuse</i> , page 109).
Analyzer prompts for the Battery ID	Turn OFF the 'Ask for Battery ID' setting in Battery Startup under the Option Controls, (see <i>To set user input</i> , page 77).
Battery continually cycles without ending on QuickTest	Battery Cells may be soft or in poor condition. Verify battery condition using the Auto program. Battery may be unable to be QuickTest.
Battery disconnected during service and is not recognized by the analyzer	If the battery is hot, the thermal fuse may have temporarily opened the battery. Lower the charge rate and allow the battery to cool before servicing again. Protection circuits in the battery may not be able to handle the rapid pulses of the OhmTest. Turn off the automatic OhmTest, (see <i>To turn Automatic OhmTest on or off</i> , page 78)
Battery has completed service but there is no LED	Contact Cadex for a firmware upgrade.

Problem	Possible Reasons or Solutions
Battery is getting hot	It is normal for batteries to heat up during charge. However, they should be just warm to the touch. If they are getting too hot, reduce the Charge rate or Trickle Charge Rate in the Extended C-code and/or activate the adapter temperature sensing.
Battery passes on analyzer but fails in the field.	Run OhmTest. If the resistance is high, the battery may not be able to hold a charge. Run Self-Discharge. If self-discharge is more than 30%, the battery may not be able to hold a charge.
Battery service does not start or is not recognized when inserted in the analyzer.	Ensure that the adapter is firmly inserted into the analyzer. Verify that the battery is correctly and firmly inserted into the adapter. Ensure that the contacts on the battery connect with the contacts on the adapter. If the battery has a switch, turn it on. Press ENTER after selecting the C-code and the service program. Verify that the selected C-code is correct for the battery. Battery voltage is too low for battery to be recognized by the unit. Run Boost, (see <i>To run the Boost program</i> , page 38).
Cannot program an 18V (or higher voltage) battery.	Batteries higher than 14.4V require the C7400ER-C. The C7200-C and C7400-C can service a maximum of 14.4V. The C7200-C and C7400-C cannot be modified to accommodate batteries higher than 14.4V.

Problem	Possible Reasons or Solutions
Capacity readings between stations are inconsistent.	Verify that the C-codes are the same between stations.
	Calibrate the stations, (see <i>To calibrate an adapter</i> , page 113).
Clicking noise is heard from the analyzer when batteries are being charged.	The noise is caused by pulse charges in the analyzer circuits. This noise is normal.
Code 150 appears when Li-ion and Li-Ph batteries are serviced. Temperature Sensing in the C-code cannot be Disabled.	For Li-ion and Li-Ph, adapters must have temperature-sensing capability. A custom-designed adapter is strongly recommended.
Connection between battery and the analyzer is intermittent.	The battery may be intrinsically safe. Change the charge method in the extended C-code to DC Charge; lower the charge and discharge rates; reduce the end-of-discharge setting to 0.92 V/cell. Ensure that the adapter is correct. Verify if the battery contacts or adapter terminals are damaged.
Capacity of the analyzer is different from the older model C7000-C analyzer.	Check that all the C-codes match. Calibrate the adapter. Set the 'Charge Optimization' to 'Charge', (see <i>Optimizing Charge Time or Capacity</i> , page 79)
Display is frozen and there are clicking sounds	Contact Cadex.
Fan changes speed.	This is normal.
LED is flashing irregularly	Contact Cadex.
NULL CODE appears on the display	C-code is blank. Program a C-code, (see <i>Create or Edit a C-code</i> , page 62).

Problem	Possible Reasons or Solutions
Program did not resume after a power failure.	<p>Default power-off time out is 1 hour. Users can increase the default time to 2; 12; 24; 48 or 72 hours.</p> <p>Note: if using BatteryShop, servicing data will not be saved.</p> <p>If the power fails during the information save (this occurs every minute), the program will not continue when power resumes.</p>
QuickTest, Q-Learn and Learn do not appear on the display	<p>Older Battery Adapters have a 4-kilobit capacity. All new Battery Adapters manufactured by Cadex, however, have a 16-kilobit capacity. (All 16K adapters are identified with a label at the back.) 16K adapters are needed for the QuickTest, Q-Learn and Learn programs.</p>
Reports or labels are not printing.	<p>Check the serial port setup for the serial printer (see <i>Connecting Other Devices to the Serial Port</i>, page 72).</p> <p>Check that the serial port is enabled for correct print device (see <i>Connecting Other Devices to the Serial Port</i>, page 72).</p> <p>Check that the serial cable is correctly configured (see <i>Typical Serial Cable Pin Configurations</i>, page 73).</p>
Resistance readings are consistently high.	<p>Calibrate the station, (see <i>Calibrating Adapters</i>, page 113).</p> <p>The battery or adapter contacts may be damaged.</p> <p>The battery is faulty.</p>
Service starts without asking for the C-code	<p>Turn ON the 'Ask for Battery C-code' setting in Battery Startup under the Option Controls, (see <i>To set user input</i>, page 77).</p>

Problem	Possible Reasons or Solutions
Single cell gives inconsistent results.	<p>Calibrate the station, (see <i>To calibrate an adapter</i>, page 113).</p> <p>Set the charge method in the extended C-code to DC Charge (for low terminal voltage).</p> <p>Single cells are discharging or charging too quickly. Lower the discharge and charge rates to 0.2 C.</p>
Temperature is not displayed on the detailed station screen during service	Turn on the temperature sensing in the C-code, (see <i>Temperature Sensing</i> , page 53).
Text is too large for the label.	Power off and power on the attached printer.
Analyzer does not respond to input and there is continuous beeping	Incomplete boot or power failure during in boot up. Remove the adapters and restart the analyzer.
No sounds are heard.	Turn on the sounds (see <i>Sound Options</i> on page 68).

Manual Updates and Other References

The Cadex website is an additional resource for information about Cadex products. Visit www.cadex.com for:

- Product specifications and technical information
- Articles
- FAQ
- Battery Adapter catalog
- User manual and firmware version updates

For more information about rechargeable batteries, *Batteries in a Portable World* (second edition) is an authoritative and popular reference book. Written by Isidor

Buchmann, Cadex President and founder, *Batteries in a Portable World* can be ordered by visiting the Cadex website or by calling Cadex Electronics Inc.

Technical Support

For a technical problem that cannot be solved with this manual or the Cadex Web site, contact our Technical Support department by phone, fax, e-mail, or mail. Provide the following information:

- Serial number of the analyzer and firmware version (press FN and then 7 to display the version number)
- Display message and/or code
- LED lights that are on or flashing
- What happened when the problem occurred?
- Move the adapter and/or battery between stations to isolate if it is a battery or adapter issue.

For questions related to batteries or adapters, also provide the following:

- Battery model number
- Adapter number
- C-code being used (including parameter settings)
- Display message and/or code

Cadex Technical Support can be reached by phone from 8:00 am to 4:30 pm, Pacific Time (GMT -8:00), Monday through Friday.

Telephone: +1 604 231-7777 ext. 315
Toll Free: +1 800 565-5228 (US and Canada only)
Fax: +1 604 231-7755
E-mail: service@cadex.com
Mail: Cadex Electronics Inc.
22000 Fraserwood Way, Richmond, BC, Canada V6W 1J6
Attn: Product Support

Appendix A

Messages and Warnings

This appendix describes all the messages and warnings that can appear on the display.

The global message is the first to appear, often with the warning code number.

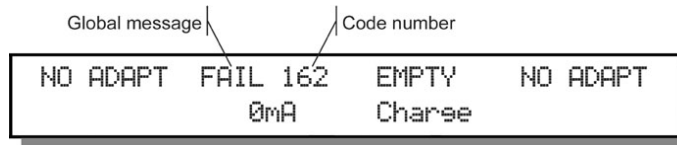

To view the detailed warning message, press the appropriate station key, in this case **2**, and then press **▼**. A display similar to this one appears:

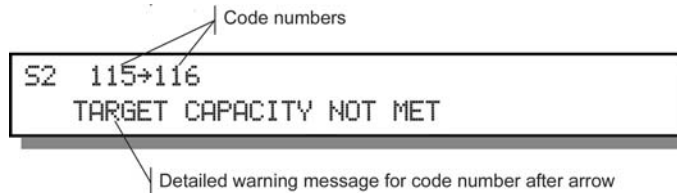

Messages and warnings are listed in this appendix by code number and by detailed message. The listing by detailed message also lists the usual reasons for the appearance of individual messages as well as possible solutions to the problems they indicate.

Non-Coded Messages

Global Message	Description
Battery Service Limit Reached	Reset the Service Counter, (see <i>To set the battery service counter</i> , page 70)
BatteryShop Mode Wait	Analyzer is waiting for input from BatteryShop software. If the unit is not connected to BatteryShop, disable the Serial Port, (see <i>Connecting to BatteryShop or a Printer</i> , page 71)
Calibration Error	The short between terminals may have disconnected during calibration. Redo the calibration.
C-code Locked	C-code is locked and cannot be edited. Use an unlocked C-code. Delete and re-enter the C-code to remove the locked C-code.
Internal Error	LCD memory is full. Press the Esc key to clear the buffer and restart the analyzer. Services may resume.
N/A	Not Applicable. QuickTest or OhmTest has not yet been completed.
N/R	Not readable. QuickTest could not determine the SoH for the battery. In most cases, the resistance may not be within acceptable limits.
NULL CODE	See Code 211 (NULL C-CODE IN ADAPTER) in the next section.
Optimizing Matrix Database	The QuickTest matrix is being built or generated after the Learn program is complete. QuickTest results are compiling. Wait for a few seconds to clear.
Unable to Print	Printer port is disabled. Serial Port and USB Port may be sharing the same printer setting. Set the serial or USB port to another device or set it to Disabled, (see <i>Connecting to BatteryShop or a Printer</i> , page 71)

By Code

In this table, messages and warnings are listed in order of code number (see *By Detailed Message*, page 129).

Code	Global Message	Detailed Message
0	OFFLINE	STATION OFF LINE
1	NO ADAPT	NO ADAPTER
2	CHARGE	CHARGING
3	TRKL CHRГ	TRICKLE CHARGE
4	RECOND.	RECONDITIONING
5	READY	READY
6	DCHG WAIT	DISCHARGE WAIT
7	DISCHARGE	DISCHARGING
8	INSERT	INSERT THE BATTERY
9	CHG WAIT	CHARGE WAIT
10	EMPTY	NO BATTERY
11	START	START BATTERY PROCESS
12	COLD WAIT	BATTERY TOO COLD
13	HOT WAIT	BATTERY TOO HOT
14	OVERHEAT	BATTERY OVER TEMP
15	FINISHED	PROCESS COMPLETE
16	WARN 16	PROGRAM HAS FAILED
17	REMOVED	BATTERY REMOVED
18	INTERRUPT	PROCESS SUSPENDED
19	RESTING	RESTING
20	INSERTED	BATTERY INSERTED
21	RESTING	RESTING
22	CAL WAIT	SETTING UP CALIBRATION
23	CALIBRATE	STATION CALIBRATING
25	RESUME	PROCESSING RESUMING
26	REMOVED	BATTERY REMOVED

Code	Global Message	Detailed Message
27	OHMTEST	RESISTANCE TEST
28	OHMTEST	RESISTANCE TEST
29	CALIBRATE	STATION CALIBRATING
30	END CYCLE	CHARGE CYCLE COMPLETE
31	END CYCLE	DCHG CYCLE COMPLETE
32	RESUMED	CYCLE RESUMED
33	END CYCLE	USER PROGRAMMED TIMEOUT
34	BATSHOP	BATSHOP MODE WAIT
35	FINISHED	PROGRAM COMPLETE or QuickTest Completed for BatteryShop
36	FINISHED	PROGRAM COMPLETE or Q-Learn completed for BatteryShop
112	ALERT 112	CELL MISMATCH
113	ALERT 113	PLATEAU TIMEOUT
115	FAIL 115	TARGET CAPACITY NOT MET in service
116	FAIL 116	TARGET CAPACITY NOT MET after service
118	ALERT 118	CHRG CURRENT REDUCED
120	FAIL 120	OVER VOLTAGE
121	REVERSED	BATTERY REVERSED
122	SHORTED	BATTERY SHORTED
123	LOW VOLT	LOW VOLTAGE TIMEOUT1
124	LOW VOLT	LOW VOLTAGE TIMEOUT2
125	LOW VOLT	NO SLOPE TIMEOUT ZONE1
126	LOW VOLT	LOW VOLTAGE AT NEG. SLOPE
127	LOW VOLT	LOW VOLTAGE TIMEOUT3
128	SOFT	UNABLE TO CLAMP CHARGE VOLTAGE
129	FAIL 129	INTERMITTENT BATTERY
130	ALERT 130	CURRENT RISE AT FULL CHARGE
135	FAIL 135	HIGH CELL RESISTANCE
136	FAIL 136	HIGH CELL RESISTANCE
142	TIMEOUT	DISCHARGE TIMEOUT

Code	Global Message	Detailed Message
144	TIMEOUT	CHARGE TIMEOUT
146	TIMEOUT	RECONDITION TIMEOUT
150	FAIL 150	THERMISTOR FAILURE
152	TEMP RISE	RAPID HEAT RISE
154	HOT BATT	CHG COMPLETE TEMP. RISE
156	TEMP RISE	HOT BATTERY, LOW VOLTAGE
158	HOT BATT	HEAT TERMINATION
159	FAIL 159	HOT BATTERY ON TRICKLE CHARGE
160	FAIL 160	BAD FUSE OR DRIVER
162	FAIL 162	DISCHARGE CURRENT LOW
164	FAIL 164	CHARGE CURRENT LOW
170	FAIL 170	CALIBRATION FAULT
171	FAULT	SMART ADAPTER FAULT
172	FAULT	SMART BATTERY FAULT
175	LOW SOC	BATTERY UNDERCHARGED
176	HIGH SOC	BATTERY OVERCHARGED
177	ALERT 177	BATTERY UNDERCHARGED
178	ALERT178	BATTERY OVERCHARGED
179	FAIL 179	UNABLE TO LEARN MATRIX
188	INTERRUPT	SERVICE INTERRUPTED
192	READY	CELL MISMATCH CORRECTED
195	READY	CAP. IMPROVED TO TARGET
200	POWER ON	POWER ON
201	ADAPT IN	ADAPTER INSERTED
202	ADAPT OUT	ADAPTER REMOVED
203	(None)	PASSWORD ENTERED
204	(None)	INVALID PASSWORD ENTERED
205	(None)	SECURITY ENABLED
206	(None)	ADAPTER SETUP UPDATED
207	SYST-TEMP	SYSTEM TEMP. HIGH: COOLING
208	FAIL 208	ADAPTER NOT SETUP

Code	Global Message	Detailed Message
209	INV ADAPT	ADAPTER DATA INVALID
210	BAD ADAPT	BAD ADAPTER
211	NULL CODE	NULL C-CODE IN ADAPTER
214	C-CODE U/S	C-CODE UNUSABLE
250	(None)	(None – battery being processed)

By Detailed Message

Detailed Message	Code	Reasons	Solutions
ADAPTER DATA INVALID	209	Invalid value in selected C-code. The C-code is not compatible with the firmware. There may be a defect with the adapter memory	Delete and re-enter the C-code reset the extended C-code to default values. Contact Cadex to upgrade firmware.
ADAPTER INSERTED	201	Adapter is detected on a station. This message appears momentarily.	If the message persists, Press Esc.
ADAPTER NOT SET UP	208	Adapter is not programmed with a C-code, or the C-code is invalid.	Delete and re-enter the C-code. Contact Cadex to upgrade firmware.
ADAPTER REMOVED	202	Adapter is removed from a station.	If message persists, press ESC.
ADAPTER SETUP UPDATED	206	Cadex BatteryShop has updated C-code in the Battery Adapter.	If message persists, press ESC.
BAD ADAPTER	210	The analyzer does not recognize adapter.	Remove and re-insert the adapter. Delete and reenter the C-code. Clean the adapter contacts. Contact Cadex to upgrade firmware. If message persists, replace adapter.

Detailed Message	Code	Reasons	Solutions
BAD FUSE OR DRIVER	160	The analyzer is not able to supply current to the battery through its current drivers. Very low values of current (about 0 mA) are displayed on the analyzer and after 10 seconds processing stops.	<p>Clean the battery and adapter contacts.</p> <p>Verify that mAh rating of the battery matches the C-code.</p> <p>Lower the Charge rate and the Trickle Charge rate in the C-code.</p> <p>Use I/S settings (see <i>Intrinsically Safe Batteries</i>, page 60) if the battery is intrinsically safe.</p> <p>The battery may be faulty. Try a different battery in the same station.</p> <p>Single Cell NiCd or NiMH batteries may produce this error on the C7400ER-C. Service single cells on the C7200-C or C7400-C.</p> <p>Check the fuses on the analyzer. If all fails, contact Cadex for service.</p>
BATSHOP MODE WAIT	34	Battery is detected on an analyzer connected to Cadex BatteryShop™. Waiting for user to start battery service in Cadex BatteryShop.	If service has been started and this message remains, verify the C-code in Cadex BatteryShop to ensure that settings are correct for the battery.
BATTERY INSERTED	20	The Cadex 7200 detects a battery in an adapter.	If message persists, press ESC.

Detailed Message	Code	Reasons	Solutions
BATTERY OVER TEMP	14	Battery has overheated during charge. Station goes to Resting 00:00 (code 19) until the battery cools.	Reduce the Charge rate in the C-code. If using a non-OEM battery, the battery thermistor may be incorrect for the adapter. Contact Cadex to upgrade the adapter.
BATTERY OVERCHARGED	176	Battery SoC (State-of-charge) is too high for QuickTest or OhmTest The battery is discharged for five minutes, after which QuickTest restarts. Discharge is repeated up to 5 times until SoC is below 90%.	If OhmTest is running, the program is aborted. Discharge the battery before running OhmTest again. Turn off the automatic OhmTest. If error continues, battery cannot be run on QuickTest or OhmTest.
BATTERY OVERCHARGED	178	Current program completed; battery SoC (State-of-charge) is too high.	Discharge the battery for 10 minutes and then charge again. Verify that correct contacts are used. Battery may have a high internal resistance. Verify with OhmTest and discard the battery.
BATTERY REMOVED	17	Battery was removed when the program completed.	This message appears briefly when the battery is removed. If message persists, press ESC.

Detailed Message	Code	Reasons	Solutions
BATTERY REMOVED	26	A five-second delay after the battery is removed when the program completed.	If message persists, press ESC.
BATTERY REVERSED	121	Battery voltage too low (less than 0.30V/cell) on insertion.	Battery may be connected backwards in the adapter. Ensure that battery leads are firmly connected to the battery. Apply a Boost.
BATTERY SHORTED	122	Battery is not accepting charge in the initial charge cycle (the voltage remains low).	Ensure battery leads are firmly connected to the battery. Battery may be fully discharged. Recharge battery in its original charger before placing it in the analyzer, or run Boost, (see <i>Boost</i> , page 38). Battery may have shorted cells - if unable to charge in the original charger, discard battery.
BATTERY TOO COLD	12	Battery temperature is too cold when inserted. The battery is trickle charged until temperature rises above 5°C	Allow the battery to warm up. If the battery is non-OEM, the thermistor may not match that on the adapter.

Detailed Message	Code	Reasons	Solutions
BATTERY TOO HOT	13	Battery temperature is too hot when inserted. The battery automatically starts processing when temperature drops 5°C below maximum value set in the C-code Temperature Sensing.	Allow the battery to cool or use the analyzer in a cooler room. If the battery is non-OEM, the thermistor may not match that on the adapter.
BATTERY UNDERCHARGE D	175	Battery SoC (State-of-charge) is too low for QuickTest or OhmTest The battery is charged for five minutes, after which QuickTest restarts. Charge is repeated up to 5 times until SoC is above 20%.	If OhmTest is running, the program is aborted. Partially charge the battery before running OhmTest again.
BATTERY UNDERCHARGE D	177	Current program completed; battery SoC (State-of-charge) low.	Charge the battery.
CALIBRATION FAULT	170	Current cannot pass through shorted terminal during calibration.	A minimum AWG 10 (2.5 mm) wire is recommended to short contacts/leads. The wires may have disconnected during the calibration process. Repeat calibration procedure.
CAP. IMPROVED TO TARGET	195	Target capacity is achieved or exceeded after an initial warning	See code 115, Target capacity not met.

Detailed Message	Code	Reasons	Solutions
C-CODE NOT USABLE	214	C-code is not suitable or is out of range for the analyzer.	<p>The C-code may have been created on an “Extended Range” (ER) analyzer or an analyzer with more recent firmware version.</p> <p>Verify required battery parameters and edit or re-enter the C-code.</p> <p>Update the firmware on the analyzer to the most recent version (see <i>Upgrading the Firmware</i>, page 110).</p>
CELL MISMATCH	112	For NiCd or NiMH batteries only. Cells are reaching full charge at different times so the negative slope is not well defined. The program proceeds to the next cycle.	<p>Wait until processing is complete because the Auto and Prime programs will attempt to correct this warning through several more charge and discharge cycles. If corrected, code 192 (Cell mismatch corrected) appears.</p> <p>Reduce the negative slope in extended C-code to 8mV/cell.</p> <p>Battery is old or has been in storage. Operating time may be reduced. Either monitor battery use or discard the battery.</p> <p>If the battery is new, use the Prime program.</p>
CELL MISMATCH CORRECTED	192	Cell mismatch (code 112) is corrected through several charge/discharge cycles.	Use the battery as normal.

Detailed Message	Code	Reasons	Solutions
CHARGE CURRENT LOW	164	Current driver cannot provide the requested charge current	See code 160, Bad fuses or driver.
CHARGE CURRENT REDUCED	118	Battery voltage exceeds maximum limit (1.8V/cell for NiMH and NiMH, 2.75V/cell for SLA). Analyzer will attempt to complete service by reducing current rate to half.	Wait until processing is complete. If voltage rises again, code 128 (Soft battery) appears and the program ends. Reduce the charge rate in the extended C-code. If the battery is new or has been in storage, use the Prime program.
CHARGE CYCLE COMPLETE	30	Charge cycle completed.	Program is going to the next step.
CHARGE TIMEOUT	144	Charge time has exceeded the expected value for the battery.	Verify that the mAh rating of the battery matches the C-code mAh setting. Analyzer may not have detected the end of charge conditions. Reduce the negative slope to 8mV/cell for NiCd and NiMH. Raise the End of Charge settings for Li-ion, Li-Ph or SLA.
CHARGE WAIT	9	Station is on hold until sufficient power is available.	This is normal if large batteries are being serviced. Service resumes automatically when sufficient power is available to the station.
CHARGING	2	Battery is being charged normally.	

Detailed Message	Code	Reasons	Solutions
CURRENT RISE AT FULL CHARGE	130	Ffor SLA and Li-ion and Li-Ph only. Battery current suddenly increased as the end-of-charge condition was achieved.	Raise the End of Charge settings. If the SLA battery is a Hawker cell, use the Hawker C-code settings (see page 60). Allow the station to complete service.
CUSTOM PROGRAM HAS FAILED – DISPLAY WILL SHOW REASON FOR FAILURE	16	(Code 16) The custom program has produced an error. The Next statement is not processed. The program has been terminated.	See the detailed display for the exact nature of battery failure. If Code 16 is displayed, then there is a bug in the custom program - verify the custom program statements.
CYCLE RESUMED	32	Power resumed or the battery is re-inserted into the adapter.	
DCHG CYCLE COMPLETE	31	Discharge cycle completed.	Program is going to the next step.
DISCHARGE CURRENT LOW	162	The analyzer cannot discharge the battery. Very low values of current (< 50mA) are displayed on the analyzer before this code appears	(See code 160, Bad fuses or driver).
DISCHARGE TIMEOUT	142	Battery capacity has exceeded 250% of the rated capacity.	Verify that the mAh rating of the battery matches the C-code mAh setting. Raise the discharge rate in the extended C-code.
DISCHARGE WAIT	6	Station is on hold until sufficient power is available.	Wait until other stations have completed battery service.

Detailed Message	Code	Reasons	Solutions
DISCHARGING	7	Battery is being discharged normally.	Program will continue when cycle has completed.
HIGH CELL RESISTANCE	135	Battery resistance has exceeded the OhmTest setpoint threshold	Program is complete (see <i>To edit the OhmTest Setpoint</i> , page 36).
HIGH CELL RESISTANCE	136	The battery resistance has exceeded the OhmTest setpoint threshold – this message is for BatteryShop	Program is complete (see <i>To edit the OhmTest Setpoint</i> , page 36).
HOT BATTERY ON TRICKLE CHARGE	159	Battery temperature has exceeded its maximum setting after service has ended and battery was on trickle charge. The trickle charge stops.	Verify that the mAh rating of the battery matches the C-code mAh setting. Reduce the Charge rate in the C-code. Reduce the trickle-charge rate or the maximum standby voltage in the extended C-code. Lower the room temperature.
HOT BATTERY, LOW VOLTAGE	156	Battery temperature went to its maximum setting in the initial charge cycle. Service terminates.	Reduce the Charge rate in the C-code. Allow battery to cool before servicing the battery again. The internal cells may have shorted or the battery is old. Either monitor battery use or discard.

Detailed Message	Code	Reasons	Solutions
HOT BATTERY/HEAT TERMINATION	158	Midway during charge the temperature went above the maximum set in the C-code. Program resumed when battery cooled by 5°C. A WAIT code may appear for the battery to cool before the next process begins.	See code 154, Charge complete temp rise. Reduce charge rate if problem persists (see page 51).
INTERMITTENT BATTERY	129	Battery connection opened five times in one minute.	Check and clean the battery contacts. Verify that correct contacts are used. Verify that the battery is properly inserted. Verify that the C-code is correct for the battery. Reduce the charge rate in extended C-code. Increase end-of-discharge voltage. For intrinsically safe batteries, use I/S settings (see <i>Intrinsically Safe Batteries</i> , page 60).
INTERNAL ERROR	(NONE)	Display Buffer is full	Machine will reset in a few minutes a resume service. If message persists, press the Esc key for a few minutes, the machine will reboot and resume service. This may occur if QuickTest (a processing intensive program) is used. Start QuickTest in each station after 10 seconds.

Detailed Message	Code	Reasons	Solutions
INVALID PASSWORD ENTERED	204	(Code 204) An incorrect password has been entered.	Enter the correct password. If correct password is unknown, contact Cadex with unit serial number.
LOW VOLTAGE (TIMEOUT 1)	123	Battery voltage remains low (less than 0.80V/cell) after approximately one minute into the charge cycle	See code 122, Battery shorted.
LOW VOLTAGE (TIMEOUT 2)	124	Battery voltage remains low (less than 0.80V/cell) after approximately ten minutes into the charge cycle	See code 122, Battery shorted.
LOW VOLTAGE (TIMEOUT 3)	127	Charge terminated. Correct voltage could not be obtained in allotted time due to high battery capacity for set charge current, incorrect voltage setting, or shorted cells.	Verify C-code settings and battery rating. Replace battery if low voltage remains.
LOW VOLTAGE AT NEG. SLOPE	126	A negative slope was detected when the battery voltage was low. I.e. The battery acted as if it was fully charged even though it was empty.	Reduce the charge rate in the Extended C-code. If battery is a high capacity NiCd, reduce the charge rate to 0.5C. Prime the battery. The battery's high impedance may be causing this failure so use the Intrinsically Safe C-code.
N/A mΩ	(NONE)	OhmTest has not been performed, so no resistance reading is available.	If all fails, discard the battery. Battery readings are above the readable values for the analyzer.

Detailed Message	Code	Reasons	Solutions
NO ADAPTER	1	No Battery Adapter is inserted, or the inserted adapter is not detected.	Check contacts. Clean with a lint-free cotton swab dipped in 100% isopropyl alcohol.
NO BATTERY	10	No battery is inserted, or the inserted battery is not detected.	Check contacts. Turn on battery switch if applicable. Check for correct battery for the adapter and adapter contacts. Clean all contacts. Run Boost, (see <i>Boost</i> , page 38).
NO NEGATIVE SLOPE ON TIMEOUT 1	125	A plateau was detected when the battery voltage was low. I.e. The battery acted as if it was fully charged even though it isn't.	Increase the charge rate in the C-code. If the battery was in storage, use Ext. Prime. If all fails, discard the battery.
NULL C-CODE IN ADAPTER	211	An empty C-code is selected.	Select a programmed C-code or program the selected empty C-code.
OVER VOLTAGE	120	Battery voltage is too high.	Verify the C-code voltage setting, (see <i>Battery Voltage (Volts)</i> , page 49). If the battery is new, charge it for a few minutes in the original charger. Li-ion and Li-Ph safety circuits may be activated. Discharge the battery in its original equipment for a few minutes. For SLA batteries, check the electrolyte. If all fails, discard the battery.

Detailed Message	Code	Reasons	Solutions
PASSWORD ENTERED	203	System password has been entered and activated.	Password is required for some actions, depending on security level selected, (see <i>Security</i> , page 74).
PLATEAU TIMEOUT	113	Battery was fully charged before full-charge conditions were met. For SLA, Li-Ion and Li-Ph only.	The end-of-charge setting in the C-code may have to be increased. Battery may be old and operating time less than manufacturer's specifications.
POWER ON	200	Power is detected inside the analyzer.	
PROCESS COMPLETE	15, 35, 36	Current battery-service program is complete.	
PROCESS RESUMING	25	(Code 25) Battery service is continuing after a power interruption.	This message appears after the initial startup screen and remains until the analyzer determines the point at which battery service was interrupted and resumes the current program from that point.
PROCESS SUSPENDED	18	Battery is removed during service.	Re-insert battery within 5 seconds to resume service. If message persists, see Code 188 for further information.
RAPID HEAT RISE	152	On initial charge, the battery temperature is rising too rapidly (2°C in 1 minute) For safety, charging is terminated.	Use ExtPrime program if the battery has been in storage Reduce the charge rate in the extended C-code. The battery may be old or have shorted cells. Discard the battery.

Detailed Message	Code	Reasons	Solutions
RAPID HEAT RISE	154	Midway during charge the temperature rose too rapidly (more than 2°C in 2 minutes). Program stops until battery is cooled by 5°C and then resumes. A WAIT code may appear for the battery to cool before the next process begins.	Wait until processing is complete. Lower the charge rate in the extended C-code. Observe battery performance. The battery may be old.
READY	5	Service has completed and battery is ready. Final capacity or state-of-health is displayed.	Faults or warnings (if any) were corrected. Remove battery and use as normal.
RECONDITION TIMEOUT	146	Recondition time has exceeded the expected value for the battery. Program goes to the next cycle.	<p>Verify the mAh settings on the C-code.</p> <p>Raise the recondition discharge rate, (see Recondition <i>Discharge Rate</i>, page 53).</p> <p>The battery may be intrinsically safe, preventing deep discharge. Use I/S settings for the battery, (see <i>Intrinsically Safe Batteries</i>, page 60)</p> <p>If battery is new or has been in storage, use the Prime program.</p> <p>Cells may be mismatched, run the Prime program.</p> <p>Monitor the battery use.</p>

Detailed Message	Code	Reasons	Solutions
RECONDITIONING	4	Battery is being reconditioned.	The program will proceed to the next step when recondition has completed.
RESISTANCE TEST	27	A manually selected or programmed resistance test for the battery is in progress.	Program completes in 5 seconds.
RESISTANCE TEST	28	An automatic resistance test in a factory program (Prime, QuickSort or Auto) is in progress.	Program completes in 5 seconds and will continue to the next step of the program.
RESTING	19	Station is in a rest period, as specified in the custom program.	The program will proceed to the next step when resting period is complete.
RESTING	21	Station is in an automatic rest period specified in the charge program for NiMH batteries when temperature sensing in the C-code is not enabled.	This message appears for NiMH batteries only. The program will proceed to the next step when resting is complete.
SECURITY ENABLED	205	System security has been activated.	Password required for some actions, depending on security level selected.

Detailed Message	Code	Reasons	Solutions
SERVICE INTERRUPTED	188	Battery is removed during service for more than five seconds. Program terminated.	<p>If the battery was not removed the battery protection circuit or thermistor may have activated disconnecting the terminals. The analyzer then thinks that the battery has been removed.</p> <p>If the battery is hot, reduce heating by lowering the Charge and Discharge. For Li-ion and Li-Ph batteries, reduce the Max Charge voltage or the Max Standby Voltage.</p>
SETTING UP CALIBRATION	22	Station is preparing for a calibration process.	<p>If message persists, remove the adapter.</p> <p>Turn off the analyzer.</p>
SMART ADAPTER FAULT	171	The analyzer has old firmware incompatible with the adapter.	Contact Cadex to obtain a firmware upgrade.
SMART BATTERY FAULT	172	The analyzer has old firmware incompatible with the adapter.	Contact Cadex to obtain a firmware upgrade.
START BATTERY PROCESS	11	Battery service has started.	If message persists, press Esc.
STATION CALIBRATING	23, 29	Station is being calibrated.	This process takes 10 – 20 seconds, wait until it completes

Detailed Message	Code	Reasons	Solutions
STATION OFF LINE	0	Station is not reading the adapter.	Remove the adapter and restart the analyzer. Make sure all analyzers have the same firmware version. Delete the C-code that was selected for the battery. Reset the system, (see <i>Resetting the System</i> , page 110).
SYSTEM TEMP. HIGH: COOLING	207	Service on all stations is temporarily suspended due to high temperature inside the analyzer.	Service will resume in a few minutes, after the board has cooled down. If it reoccurs continually, move the analyzer to a cooler room. The firmware chip in the analyzer may be loose. Contact Cadex for instructions to reinsert firmware.
TARGET CAPACITY NOT MET	115	Battery capacity is below the target capacity. The analyzer attempts to improve the capacity by reconditioning the battery.	Wait until service is complete. The Auto and Prime programs will try to correct this warning. If corrected, Code 195 appears. If not corrected, Code 116 appears. See Code 195 and 116 for further information.
TARGET CAPACITY NOT MET	116	Final capacity of the battery is below the target capacity. Attempts to improve battery capacity did not succeed in bringing capacity above target.	Confirm that the battery rating matches the C-code mAh setting. Battery is old and has less operating time than manufacturer's specification.

Detailed Message	Code	Reasons	Solutions
THERMISTOR FAILURE	150	The battery temperature reading is invalid.	Clean the contacts on the battery. Thermistors on non-OEM batteries may not be the same as that used on OEM batteries. Contact Cadex to upgrade the adapter. If the battery is NiCd or NiMH, turn off the temperature sensing. If the battery is known to be good or the adapter has two contacts (in these adapters, the negative contact is a thermistor), the battery thermistor is defective, contact Cadex.
TRICKLE CHARGE	3	The program is running a trickle charge. The reconditioning process is complete, and the battery is being recharged.	

Detailed Message	Code	Reasons	Solutions
UNABLE TO CLAMP CHARGE VOLTAGE	128	<p>Battery voltage is too high: NiCd and NiMH - more than 1.8V/cell SLA – more than 2.75V/cell. Li-ion – more than 4.5V/cell Li-Ph – more than 3.85V/cell Processing has ended.</p>	<p>Battery may be a high capacity type battery. Reduce the charge rate.</p> <p>Battery may be overcharged. Discharge the battery for 10 minutes, and then charge again.</p> <p>Battery is new. Use the Prime program to prepare the battery for use.</p> <p>Raise End of Charge (SLA, Li-ion ad Li-Ph) to 0.10C.</p> <p>Check that correct contacts are used.</p>
UNABLE TO LEARN MATRIX	179	<p>A matrix cannot be created because: battery capacity is less than 50%, the OhmTest reading does not produce a result or the battery cannot handle 1.00C charge or discharge rate required by Learn</p>	<p>Use another battery to run Q-Learn or Learn.</p>
USER PROGRAMMED TIMEOUT	33	<p>The time programmed in a custom program has completed.</p>	<p>The program goes to the next step.</p>

Appendix B

Charge Algorithms

The C7000-C series battery analyzer uses two different algorithms to charge a battery: a constant current (CC) method for NiCd and NiMH batteries and a constant current/constant voltage (CC/CV) method for Li-ion, Li-Ph and SLA batteries.

NiCd and NiMH batteries

The C7x00 analyzer uses a constant current algorithm to charge NiCd and NiMH batteries. A current and voltage plot is shown for a typical NiCd battery serviced on the analyzer using default values. This plot is similar to a NiMH battery.

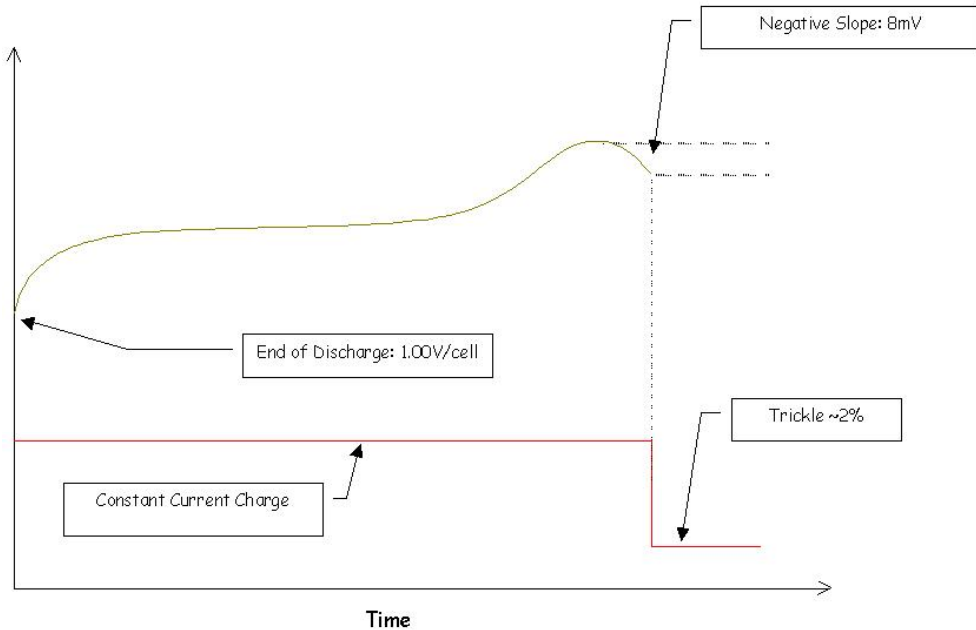

A battery that is fully discharged is about 1.00V/cell. During charge, the analyzer applies a constant current. As the battery gets charged, the voltage rises. Charge is terminated depending on how the NiCd and NiMH Optimization have been set (see *Setting the Optimization*, page 79).

If NiCd and NiMH Optimization have been set to Capacity, the battery is terminated when a negative slope (a gradual voltage drop indicating that the battery is fully charged) is encountered. If there is a voltage plateau or temperature rise more than dT/dt , the current is reduced by half and the charge continues until the battery reaches full charge. For NiMH batteries, the current is often reduced by half twice.

If NiCd and NiMH Optimization have been set to Time (this is the default setting), the temperature will be monitored and charge will terminate when the battery reaches either the negative slope, dT/dt or maximum battery temperature.

This table summarizes the charge methods:

NiCd and NiMH Optimization	dT/dt	Negative Slope (dV/dt)	Max Temperature
Capacity	Current is reduced	Charge is complete	Current is reduced
Time	Charge is completed	Charge is completed	Charge is completed

SLA, Li-ion and Li-Ph Batteries

The C7x00 analyzer uses a Constant Current/Constant Voltage Charge algorithm to charge SLA, Li-ion and Li-Ph batteries. A current and voltage plot is shown for a typical Li-ion battery serviced on the analyzer with default C-code settings. This plot is similar for the SLA battery.

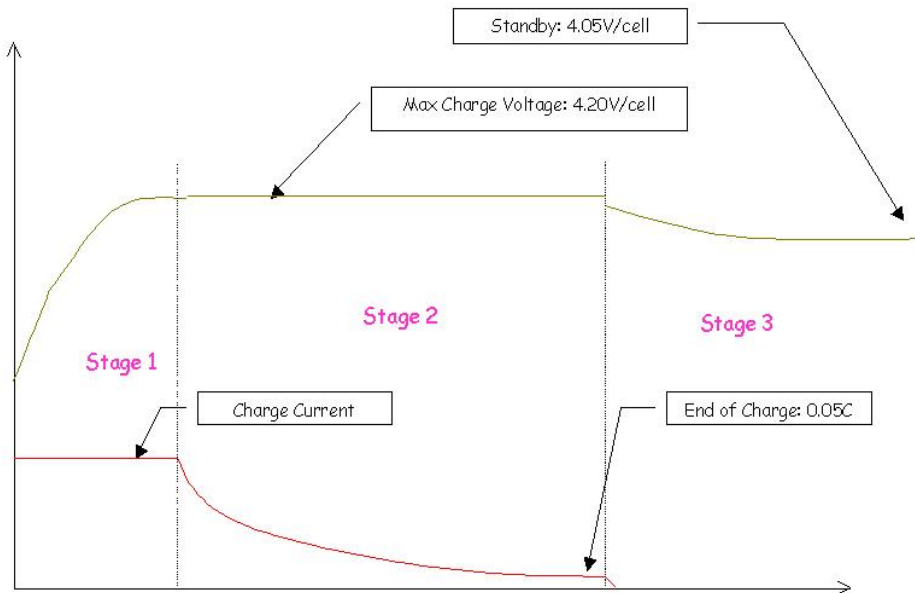

There are three stages during the charge:

Stage 1: the battery is charged at a constant current (this current is the 'Charge Rate' in the Extended C-code) until the battery reaches the Maximum Charge Voltage (set in the Extended C-code) is reached.

Stage 2: When the battery reaches Maximum Battery Voltage, the analyzer switches to constant voltage. During this stage, current is reduced to maintain Maximum Charge Voltage until the End of Charge current (set in the C-code) is reached.

If SLA and Li Optimization are set to Capacity (*see Saving Program and Target Capacity Settings*, page 79), the charge time is extended for approximately 20 minutes after End of Charge has been reached. This additional charging period may add 4% to 6% capacity; however, the small increase in capacity may not be worth the additional time.

If SLA and Li Optimization are been set to Time (this is the recommended setting), charge will terminate as soon as End of Charge has been reached.

In both cases of Optimization settings, exceeding dT/dt will fail a battery.

Stage 3: After the charge has completed, the battery is maintained at a constant voltage level (this is voltage is the Maximum Standby Voltage set in the C-code).

This table summarizes the charge methods:

SLA and Li Optimization	dT/dt	End of Charge	Max Temperature
Capacity	Fail 152 or Fail 158	Approximately extra ~20 minutes charge time added	Charge continues after temperature drops 5°C below max threshold
Time	Fail 152 or Fail 158	Charge completes as soon as end of Charge is reached.	Charge continues after temperature drops 5°C below max threshold

Appendix C

Specifications

Hardware

Battery Analyzers	C7200-C	C7400-C	C7400ER-C
Part Numbers	07-720-0100	07-740-0100	07-740-1100
Independent stations	2	4	4
Battery voltage	1.2-16V	1.2-16V	Li-ion and SLA 1.2-36V NiCd and NiMH: 1.2 – 28.8V
Charge/discharge current	100mA-4A	100mA-4A	100mA-6A*
Accuracy	+/- 1% at max rated voltage, +/- 2% at 4000mA Services batteries up to 24Ah. If set above 4A*, the current automatically scales down.		
Maximum charge power	40W per station; 40W total	55W per station; 80W total	75W per station; 170W total
Maximum discharge power	35W per station; 70W total	35W per station; 140W total	75W per station; 200W total
Power management	On high load demands, the current scales down; large batteries may go on waiting queue		
Line voltages	100-240VAC, 50- 60Hz; 1.5A max	100-240VAC, 50- 60Hz, 1.75A max	100-120/200-240VAC, 50-60Hz; 4A max
Chemistries	Lithium-ion, Lithium-phosphate, nickel-metal-hydrate, nickel-cadmium, lead-acid		
Charge method	Automatic full charge detection, safe termination under all conditions. Temperature controlled. Lithium-phosphate, Lithium-ion and lead-acid: constant voltage with current limit. Nickel-based: constant current with Reverse Load adjustable from 5-12%. Customized charge methods possible.		
Discharge method	Constant discharge current to end-of-discharge voltage threshold		
Battery Adapters	Custom and universal SnapLock™ adapters. Each adapter holds up to 10 C-codes to service different battery types. Re-programmable with menu function.		

	Temperature controlled.		
Security	Level 0	Open, no programming restrictions (default)	
	Level 1	Password protected (low); allows C-code selection and display options	
	Level 2	Password protected (high); most programming choices are locked	
Display	80-character LCD, backlit; each station also features RUN, READY, FAIL signal lights		
Data Ports	USB port: to connect to PC for BatteryShop™ and USB label printers. Serial port – to print to label printers		
Throughput	QuickSort™	30-40 batteries/hr	60-80 batteries/hr
	Full service	Fleet of 80 batteries typical	Fleet of 160 batteries typical
	Throughput on full service is based on recommended monthly maintenance. Each analyzer services two battery batches every 24h (day and night run), 20 days per month.		
Physical	Length	12.1"; 312mm	14.4"; 360mm
	Width	9.4"; 240mm	11.0"; 280mm
	Height	3.5"; 90mm	3.8"; 100mm
	Weight	7.1lb.; 3.2 kg	10.05lb.; 4.54kg
Environmental	Operating temperature 41°F to 95 °F; 5°C to 35°C Storage temperatures –40°F to 167°F; -40°F to 75°C		
Firmware	Upgradeable with BatteryShop, flash memory. Lifetime upgrade subscription available.		
Approvals	Tested and approved by ITS to comply with CSA/UL/CE standards.		
Warranty	Cadex warrants the analyzer against defective materials and workmanship for a period of two (2) years from the original purchase date.		

* 6A charge/discharge current is only available with specialized / customer adapters.

Appendix D

Parts and Accessories

Part	Cadex Part Number (P/N)
Cadex Battery Adapters	Visit www.cadex.com for the latest list
Smart Cable	07-110-0115
FlexArm Adapter	07-110-0180
RigidArm	07-110-0190
DYMO SE300 Label Printer	00-004-3013
DYMO Battery Labels, 1500/roll	00-004-3031
C7000 C-Series Voltage-calibration kit (with instructions and calibration adapters)	92-770-0212
Power Cord, 6'	68-723-1804
Cadex User's Manual	89-307-1013
C7200-C & C7400-C Primary Fuse T2.0A 250 V	52-546-0200
C7400ER-C Primary Fuse T5.0A 250V	52-546-0500
Cadex BatteryShop (Windows based Battery-Management Software)	Contact Cadex Electronics Inc. or an authorized Cadex dealer.
Book: <i>Batteries in a Portable World</i> , 2 nd edition	Contact Cadex Electronics Inc. or visit our Web site (www.cadex.com).

Index

- adapters, battery17, 154
 - 16 kilobit.....28, 40, 42, 44, 119
 - calibrating113
 - copying65
 - inserting19, 20
 - removing19
 - setup report.....83
 - Smart Cable.....18, 47, 51, 113
- adapters, custom... *See* adapters, battery
- adapters, voltage calibration
 - servicing.....113
- advanced programs....*See also* programs
 - Boost.....31, 38
 - custom31, 45
 - Discharge Only30, 34
 - editing32, 36, 37
 - Extended Prime30, 35
 - Learn.....31, 40, 42
 - Life Cycle Test.....30, 33
 - OhmTest.....30, 36
 - RunTime37
 - Self-Discharge Test30, 31
- Auto program.....25, 26
- automatic OhmTest78, 131, 133
- Auto-Print86
- bar code labels85
- basic programs.....25. *See also* programs
 - Auto25, 26
 - Charge25, 27
 - Prime26, 27
 - Quicktest.....26, 31
- batteries
 - basic service20
 - displaying number serviced.....71
 - Gell SLA.....61
 - Hawker SLA.....51, 60, 136
 - inserting20
 - intrinsically safe.....51, 60, 118, 142
 - removing19
 - service programs25
 - service time.....46
 - servicing.....20
 - smart.....8
 - voltage49
- Batteries in a Portable World*.....120, 154
- battery adapters.....17, 154
 - 16 kilobit.....28, 40, 42, 44, 119
 - calibrating113
 - copying65
 - inserting19, 20
 - removing19
 - setup report.....83
 - Smart Cable.....18, 47, 51, 113
- battery capacity50
- battery chemistries49
- battery labels83
- battery rating.....50
- battery service counter70
 - disabling.....70
 - restarting.....70
 - setting70
- battery service report.....83, 85
- battery startup setting.....77
- Boost*See* Boost program

Boost program.....	31, 38, 132, 140	recondition discharge rate	53
editing.....	39	temperature sensing.....	54
running	39	trickle-charge rate.....	53
Buchmann, Isidor	120	C-Codes	18
Cadex Batteryshop 45, 83, 110, 129, 130, 154		copying	65
connecting to	72	creating.....	62
Cadex Firmware Utility	110	deleting	65
calibrating		displaying.....	21, 61
battery adapters.....	113	editing.....	62, 64
stations	113	managing.....	61
voltage.....	112	naming.....	50
calibration.....	112	resetting extended parameters	64
calibration adapters		selecting	22, 61
servicing	113	setting active.....	61
calibration kit	154	setup name.....	50
capacity		changing	
battery	50	password	76
target	8, 49, 80, 107, 133, 145	target capacity	62
C-Code parameters, basic	48	charge	
battery capacity	50	end of	57
battery rating.....	50	optimizing	79
battery voltage.....	49	rate	51
chemistry	49	trickle	8, 53
mAh	50	Charge program	25, 27
program	48	chemistry, battery	49
target capacity	49	clearing event log	91
type.....	49	components.....	11, 12
volts	49	computer, connecting to	71, 72
C-Code parameters, extended	51	confidence grade.....	44, 93
charge rate	51	configurations, serial cable pin	74
C-Rate	51	connecting	
discharge rate.....	52	to Cadex Batteryshop	72
end of charge.....	57	to computer.....	71, 72
end of discharge.....	54	to label printer.....	71, 72
negative slope	54	to printer	71
		copying	

battery adapters.....	65	C-Codes.....	21, 61
C-Codes.....	65	event log	90
Quicktest matrices	65	firmware version.....	110
counter, battery service	<i>See</i> battery	number of batteries serviced.....	71
service counter		done phase.....	104
C-Rate (C)	51	editing	
creating		Boost program	39
C-Codes.....	62	C-Codes.....	62, 64
custom programs	105	custom programs	105
custom adapters.....	<i>See</i> battery adapters	Discharge Only program	34
custom programs.....	31, 45, 100	Life Cycle Test program	33
creating	105	OhmTest program	36
editing	105	RunTime program	37
phases	101, 102, 104	Self-Discharge Test program	32
cycle 1	101	target capacity.....	62
cycle 2	101	ELSE statements.....	104
data log.....	91	end of charge.....	57
setting up	96	end of discharge	54
default settings		event log.....	89
extended C-Codes	59, 60	clearing	91
deleting		displaying	90
C-Codes.....	65	events	89
detailed display	14	printing	90
devices		extended C-Codes	
output.....	71	default settings.....	59, 60
discharge		Extended Prime program.....	30, 35
end of.....	54	FALSE statements.....	104
rate	52	firmware	
recondition	53	displaying version	110
self	8	upgrading	110
Discharge Only program.....	30, 34	function (Fn) keys	11, 64, 65, 71, 110,
editing	34	112, 113	
display.....	123	fuse	
detailed.....	14	primary (input).....	154
lights (LEDs)	15	replacing.....	109
displaying		Gell SLA batteries.....	61

Hawker SLA batteries	51, 60, 136	negative slope	54
IF statements	102	NULL code	20, 128
input fuse	154	OhmTest program .	30, 36, 111, 113, 131, 133
replacing.....	109	editing.....	36
inserting		OhmTest, automatic.....	78, 131, 133
batteries.....	20	optimizing charge	79
battery adapters.....	19, 20	output devices	71
internal resistance	<i>See</i> resistance	parameters, basic C-Code ...	<i>See</i> C-Code
intrinsically safe batteries	51, 60, 118, 142	parameters, basic	
keys.....	11, 12	parameters, extended C-Code	<i>See</i>
function (Fn) ..	11, 64, 65, 71, 110, 112, 113	C-Code parameters, extended	
label printer	72	parts	11, 12
connecting to	71, 72	passwords	
labels		changing	76
bar code	85	required at security levels	74
battery	83	phases, custom programs	
printing.....	87	cycle 1	101
Learn program.....	31, 40, 42	cycle 2	101
LEDs	15	done	104
Life Cycle Test program	30, 33, 111	test.....	102
editing.....	33	primary (input) fuse	154
lights (LEDs).....	15	replacing	109
Li-Ph..	1, 6, 26, 27, 28, 33, 38, 46, 49, 50, 53, 55, 56, 57, 59, 101, 118, 135, 136, 140, 141, 144, 147, 148, 150	Prime program	26, 27, 142
log		printer	
data	<i>See</i> data log	connecting to	71
event.....	<i>See</i> event log	label.....	72
managing		printing	
C-Codes	61	event log	90
matrix, Quicktest	44	reports and labels	87
copying	65	programs	48
messages.....	92, 123	Auto	25, 26
modifying.....	<i>See also</i> editing	basic.....	25
name, C-Code.....	50	battery service	25
		Boost	31, 38, 132, 140
		Charge.....	25, 27

custom	31, 45, 100	adapter setup	83
creating	105	battery service.....	83, 85
editing.....	105	printing.....	87
phases.....	101, 102, 104	system setup.....	83
Discharge Only	30, 34	resetting extended C-Code parameters	64
editing specialty	32, 36, 37	resistance	
Extended Prime	30, 35	defined	8
Learn.....	31, 40, 42	running	
Life Cycle Test.....	30, 33, 111	Boost program	39
OhmTest.....	30, 36, 111, 113, 131, 133	RunTime program.....	37, 111
Prime	26, 27, 142	editing	37
Quicktest.....	26, 31, 93, 113, 131, 133	security	74
RunTime	37, 111	levels.....	74
Self-Discharge Test	30, 31, 111	passwords.....	74
service time.....	46	removing	76
QuickLearn	40, 42	setting level.....	76
QuickSort.1, 25, 26, 28, 46, 94, 113, 143,	153	selecting	
Quicktest matrices.....	44	automatic OhmTest.....	78
copying	65	C-Codes.....	22, 61
Quicktest program ...	26, 31, 93, 113, 131,	charge optimization.....	79
133		correct voltage	49
rate		self-discharge	8
charge.....	51	Self-Discharge Test program..	30, 31, 111
discharge	52	editing	32
recondition discharge.....	53	serial cable pin configurations	74
trickle charge	53	serial device settings	72
rating, battery	50	serial port settings	96
recondition discharge rate	53	service counter	<i>See</i> battery service
removing		counter	
batteries.....	19	services	<i>See also</i> programs
battery adapters.....	19	servicing	
security	76	batteries	20
replacing		voltage calibration adapters	113
primary (input) fuse.....	109	setting	
reports		active C-Code	61
		password	76

security level.....	76	voltage.....	69
sound control.....	68	system setup report.....	83
settings		target capacity 8, 49, 80, 107, 133, 145	
default extended C-Codes.....	59, 60	changing.....	62
serial device.....	72	technical support.....	121
serial port.....	96	temperature sensing.....	54
system.....	<i>See system settings</i>	terminal.....	96
setup name, C-Code.....	50	test in custom program.....	102
slope, negative.....	54	tests	
smart batteries.....	8	automatic OhmTest.....	78, 131, 133
Smart Cable Adapters	17, 18, 47, 51, 113	Life Cycle.....	30, 33, 111
SOC.....	<i>See State of Charge</i>	OhmTest.....	30, 36, 111, 113, 131, 133
SOH.....	<i>See State of Health</i>	Quicktest.....	26, 31, 113, 131, 133
sounds.....	68	RunTime.....	37
specialty programs.....	<i>See advanced</i>	Self-Discharge.....	30, 31, 111
programs		THEN statements.....	104
State of Charge.....	8, 44, 131, 133	trickle charge.....	8
State of Health.....	8, 44, 93	rate.....	53
statements		troubleshooting.....	116
ELSE.....	104	TRUE statements.....	104
FALSE.....	104	upgrading firmware.....	110
IF 102		version, firmware.....	110
THEN.....	104	viewing.....	<i>See displaying</i>
TRUE.....	104	voltage	
stations, calibrating.....	113	battery.....	49
system security.....	<i>See security</i>	calibrating.....	112
system settings.....	67	calibration adapters	
automatic OhmTest.....	78	servicing.....	113
battery startup.....	77	calibration kit.....	154
calibration.....	112	display setting.....	69
charge optimization.....	79	selecting correct.....	49
sounds.....	68	warnings.....	92, 123